



STUA





PRICEBOOK 2026

RETAIL PRICES IN \$ FOR THE USA





I N D E X

Click on the icon to go to the product



CHAIRS & STOOLS

- 6 GLOBUS 
- 10 GAS 
- 16 EGOA 
- 22 LACLASICA 
- 26 ONDA 



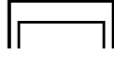

LOUNGE

- 64 CALMA 
- 70 NUBE 
- 74 MALENA 
- 78 LIBERA 
- 82 COSTURA 



TABLES

- 30 PETAL 
- 36 DENEK 
- 42 ZERO 
- 48 LAU 

COFFEE-TABLES

- 52 MAREA 
- 54 SOLAPA 
- 56 ECLIPSE 
- 58 MESETA 
- 60 PAUSA 

SAPPORO & SATELLITE

- 102 SATELLITE 
- 106 SAPPORO 

SAMPLES AND CATALOGUES

SAMPLE CARDS

BINDERS AND DISPLAY

CATALOGUES

STUA IN YOUR SHOWROOM



Technical textiles (21)



Box



Soft-touch textiles (32)



The narrow binder containing all the sample cards



Leather

Artificial leather



The wide binder containing large Soft fabric samples

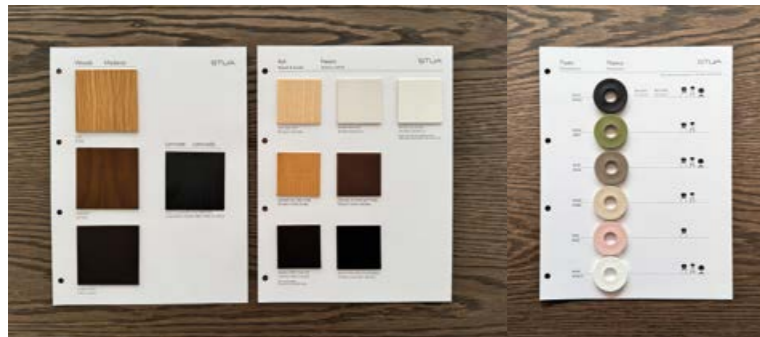

Wood

Stained ash wood

Polypropylene



Display



Slow Design book



Pricebook



Resume catalogue for end customers



Micro catalogue that accompanies the products

REQUEST FOR DEALERS MATERIAL

Ask us for the commercial material you need by sending an email to export@stua.com

SHOWROOM DISCOUNT

STUA wants to help every store to display the collection on the showroom. This is why we have the special "Showroom display discount" programme.

Each store has the right to make one order per year with these conditions.

SUSTAINABILITY

CARING FOR THE ENVIRONMENT, EVERY DAY

At STUA, we are continuing to implement measures to renew our environmental commitment. This year, our focus is on reducing our carbon footprint.

During 2025, the photovoltaic panels on the factory roof have already generated clean electricity for our own consumption.

This has had a real impact:

48 tonnes of carbon have been saved.

31 tonnes of CO₂ avoided.

This is equivalent to the annual absorption of more than 2.000 trees.

The new recycled Vescom fabrics are made from up to 100% recycled PET plastic. For every metre of fabric, we remove 45 plastic bottles from the sea.

Our web servers are now more environmentally friendly, with a reduced carbon footprint thanks to more efficient equipment and technologies, as well as the use of 100% carbon-free energy.

We are continuing to make progress with our paperless office plan.

Our small bamboo forest and its surroundings continue to grow around our new headquarters, with more than 800 trees and plants.

And as always, we remain committed to highly durable designs and materials. Durable furniture for a sustainable world.

Learn more about our environmental commitment:

www.stua.com/about-us/



ENVIRONMENT



S L O W D E S I G N
M A D E I N S P A I N

GLOBUS



Stone-coloured plastic



Oak



Walnut



Stainless steel for outdoor use

CHAIR



STOOL



GLOBUS



FAST DELIVERY, SHIPS IN ONE WEEK

FRAME		SEAT & BACK		CHAIR 45cm		KITCHEN STOOL 65 cm	
BLACK	BLACK	Recycled polypropylene		CODE 222	RETAIL 342 \$	CODE 222C	RETAIL 432 \$
BLACK	STONE			CODE 220	RETAIL 342 \$	CODE 220C	RETAIL 432 \$
BLACK	TAUPE			CODE 223	RETAIL 342 \$	CODE 223C	RETAIL 432 \$
BLACK	OAK			CODE 22W5	RETAIL 589 \$	CODE 22W5C	RETAIL 679 \$
WHITE	STONE			CODE 240	RETAIL 342 \$	CODE 240C	RETAIL 432 \$

The fast delivery Globus have plastic glides.

THESE GLOBUS ARE SHIPPED WITHIN 1 WEEK
THE REST ARE SHIPPED WITHIN 3 WEEKS

GLOBUS PLYWOOD

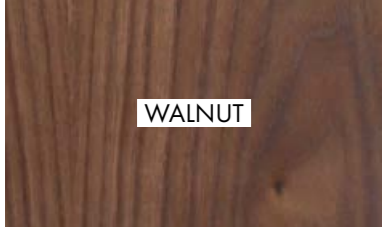
SEAT & BACK	FRAME	CHAIR 45cm		KITCHEN STOOL 65 cm		BAR STOOL 75 cm	
		CODE	RETAIL	CODE	RETAIL	CODE	RETAIL
 OAK	BLACK	22W5	589 \$	22W5C	679 \$	22W5B	700 \$
	WHITE	24W5	589 \$	24W5C	679 \$	24W5B	700 \$
	SHINY CHROME	20W5	643 \$	20W5C	733 \$	20W5B	754 \$
	MATT STAINLESS STEEL	26W5	695 \$				
 WARM GREY	BLACK	2237	589 \$	2237C	679 \$	2237B	700 \$
	WHITE	2437	589 \$	2437C	679 \$	2437B	700 \$
	SHINY CHROME	2037	643 \$	2037C	733 \$	2037B	754 \$
	MATT STAINLESS STEEL	2637	695 \$				
 WALNUT	BLACK	22W9	616 \$	22W9C	706 \$	22W9B	727 \$
	WHITE	24W9	616 \$	24W9C	706 \$	24W9B	727 \$
	SHINY CHROME	20W9	670 \$	20W9C	760 \$	20W9B	781 \$
	MATT STAINLESS STEEL	26W9	722 \$				
WITH BLACK FELT GLIDES		+T	+36 \$	+T	+36 \$	+T	+36 \$

UPHOLSTERED SEAT







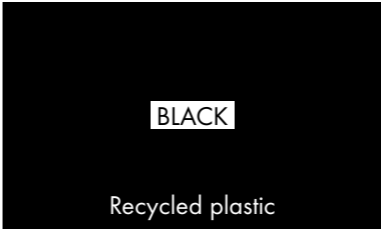

Code of the upholstered chair = Chair code +AT +fabric code.

UPHOLSTERED SEAT	CODE	RETAIL
G1 fabric upholstery	+AT	+139 \$
G2 fabric upholstery	+AT	+139 \$
G3 fabric upholstery	+AT	+139 \$
Leather or G4 fabric upholstery	+AT G4	+257 \$
COM fabric upholstery	+AT COM	+139 \$

UPHOLSTERY	SEE PAGES
Fabrics	114 - 119
Artificial leather	120
Leather	121

GLOBUS POLYPROPYLENE

SEAT & BACK	FRAME	CHAIR 45cm		KITCHEN STOOL 65 cm		BAR STOOL 75 cm	
		CODE	RETAIL	CODE	RETAIL	CODE	RETAIL
 BLACK Recycled plastic	BLACK	222	342 \$	222C	432 \$	222B	454 \$
	WHITE	242	342 \$	242C	432 \$	242B	454 \$
	SHINY CHROME	202	396 \$	202C	486 \$	202B	508 \$
	MATT STAINLESS STEEL ▲	262	448 \$				
 GREEN	BLACK	228	342 \$	228C	432 \$	228B	454 \$
	WHITE	248	342 \$	248C	432 \$	248B	454 \$
	SHINY CHROME	208	396 \$	208C	486 \$	208B	508 \$
	MATT STAINLESS STEEL ▲	268	448 \$				
 TAUPE	BLACK	223	342 \$	223C	432 \$	223B	454 \$
	WHITE	243	342 \$	243C	432 \$	243B	454 \$
	SHINY CHROME	203	396 \$	203C	486 \$	203B	508 \$
	MATT STAINLESS STEEL ▲	263	448 \$				
 STONE	BLACK	220	342 \$	220C	432 \$	220B	454 \$
	WHITE	240	342 \$	240C	432 \$	240B	454 \$
	SHINY CHROME	200	396 \$	200C	486 \$	200B	508 \$
	MATT STAINLESS STEEL ▲	260	448 \$				
 PALE PINK	BLACK	229	342 \$	229C	432 \$	229B	454 \$
	WHITE	249	342 \$	249C	432 \$	249B	454 \$
	SHINY CHROME	209	396 \$	209C	486 \$	209B	508 \$
	MATT STAINLESS STEEL ▲	269	448 \$				
 WHITE	BLACK	224	342 \$	224C	432 \$	224B	454 \$
	WHITE	244	342 \$	244C	432 \$	244B	454 \$
	SHINY CHROME	204	396 \$	204C	486 \$	204B	508 \$
	MATT STAINLESS STEEL ▲	264	448 \$				
WITH BLACK FELT GLIDES		+T	+36 \$	+T	+36 \$	+T	+36 \$

THE GLOBUS HIGHLIGHTED IN PINK ARE SHIPPED WITHIN 1 WEEK
THE REST ARE SHIPPED WITHIN 3 WEEKS

WITHOUT ARMS



SIDECHAIR
White frame
Fabric Camira Main Line Flax 20
84 FAM020

SELF-RETURN
Chromed frame
Fabric Camira Main Line Flax 60
80 A FAM060

TASK CHAIR
Black frame
Fabric Camira Main Line Flax 15
82 R FAM015

WITH ARMS



ARMCHAIR
White frame
Fabric Camira Main Line Flax 2
84 B FAM002

SELF-RETURN
Chromed frame
Fabric Camira Main Line Flax 26
80 BA FAM026

TASK CHAIR
Black frame
Fabric Camira Main Line Flax 16
82 BR FAM016





WITH LEGS



SWIVEL CHAIR

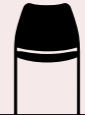
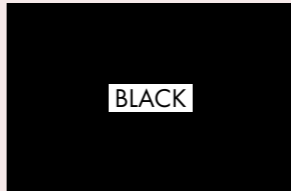

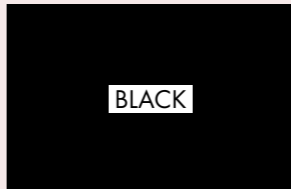
FAST DELIVERY, SHIPS IN ONE WEEK

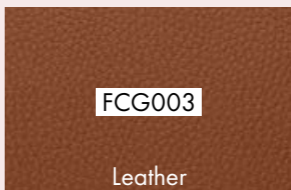
FRAME		SEAT & BACK	 SIDE CHAIR				
 BLACK	 BLACK Polypropylene		<table border="0"> <tr> <td>CODE</td> <td>RETAIL</td> </tr> <tr> <td>8222</td> <td>518 \$</td> </tr> </table>	CODE	RETAIL	8222	518 \$
CODE	RETAIL						
8222	518 \$						
FRAME		SEAT AND BACK	 TASK CHAIR WITH ARMS with wheels Adjustable height				
 BLACK	 FET002 Artificial leather		<table border="0"> <tr> <td>CODE</td> <td>RETAIL</td> </tr> <tr> <td>82 BR FET002</td> <td>1435 \$</td> </tr> </table>	CODE	RETAIL	82 BR FET002	1435 \$
CODE	RETAIL						
82 BR FET002	1435 \$						
 BLACK	 FET007 Artificial leather		<table border="0"> <tr> <td>CODE</td> <td>RETAIL</td> </tr> <tr> <td>82 BR FET007</td> <td>1435 \$</td> </tr> </table>	CODE	RETAIL	82 BR FET007	1435 \$
CODE	RETAIL						
82 BR FET007	1435 \$						
 WHITE	 FET005 Artificial leather		<table border="0"> <tr> <td>CODE</td> <td>RETAIL</td> </tr> <tr> <td>84 BR FET005</td> <td>1435 \$</td> </tr> </table>	CODE	RETAIL	84 BR FET005	1435 \$
CODE	RETAIL						
84 BR FET005	1435 \$						
 BLACK	 FCG003 Leather		<table border="0"> <tr> <td>CODE</td> <td>RETAIL</td> </tr> <tr> <td>82 BR FCG003</td> <td>1750 \$</td> </tr> </table>	CODE	RETAIL	82 BR FCG003	1750 \$
CODE	RETAIL						
82 BR FCG003	1750 \$						

THESE GAS CHAIRS ARE SHIPPED WITHIN 1 WEEK
THE REST ARE SHIPPED WITHIN 3 WEEKS

GAS POLYPROPYLENE



Taupe



White



Black



Black

MESH-BACK



Any Gas chair can be fitted with a net back.

EXTRA COST PER CHAIR	CODE	RETAIL
Black mesh-back	+32	+180 \$
White mesh-back	+34	+180 \$

* White net available while stocks last.



GAS POLYPROPYLENE

WITHOUT ARMS

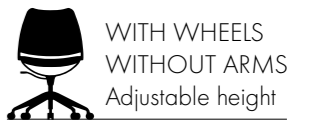
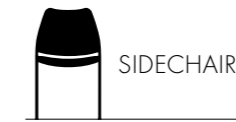

SEAT & BACK	FRAME FINISH	CODE	RETAIL	CODE	RETAIL	CODE	RETAIL
BLACK	BLACK	8222	518 \$	8222 A	1062 \$	8222 R	1062 \$
	WHITE	8422	518 \$	8422 A	1062 \$	8422 R	1062 \$
	SHINY CHROME	8022	626 \$	8022 A	1170 \$	8022 R	1170 \$
TAUPE	BLACK	8223	518 \$	8223 A	1062 \$	8223 R	1062 \$
	WHITE	8423	518 \$	8423 A	1062 \$	8423 R	1062 \$
	SHINY CHROME	8023	626 \$	8023 A	1170 \$	8023 R	1170 \$
WHITE OPAQUE	BLACK	8224	518 \$	8224 A	1062 \$	8224 R	1062 \$
	WHITE	8424	518 \$	8424 A	1062 \$	8424 R	1062 \$
	SHINY CHROME	8024	626 \$	8024 A	1170 \$	8024 R	1170 \$

+T: WITH FELT GLIDES

WITH ARMS

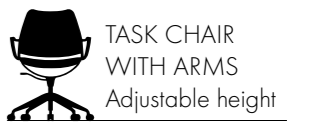
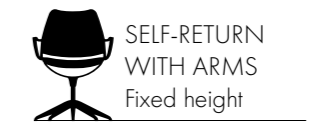

SEAT & BACK	FRAME FINISH	CODE	RETAIL	CODE	RETAIL	CODE	RETAIL
BLACK	BLACK	8222 B	675 \$	8222 BA	1219 \$	8222 BR	1219 \$
	WHITE	8422 B	675 \$	8422 BA	1219 \$	8422 BR	1219 \$
	SHINY CHROME	8022 B	783 \$	8022 BA	1327 \$	8022 BR	1327 \$
TAUPE	BLACK	8223 B	675 \$	8223 BA	1219 \$	8223 BR	1219 \$
	WHITE	8423 B	675 \$	8423 BA	1219 \$	8423 BR	1219 \$
	SHINY CHROME	8023 B	783 \$	8023 BA	1327 \$	8023 BR	1327 \$
WHITE OPAQUE	BLACK	8224 B	675 \$	8224 BA	1219 \$	8224 BR	1219 \$
	WHITE	8424 B	675 \$	8424 BA	1219 \$	8424 BR	1219 \$
	SHINY CHROME	8024 B	783 \$	8024 BA	1327 \$	8024 BR	1327 \$

THE GAS HIGHLIGHTED IN PINK IS SHIPPED WITHIN 1 WEEK
THE REST ARE SHIPPED WITHIN 3 WEEKS

+T: WITH FELT GLIDES

GAS : UPHOLSTERED

ALL VALID FABRICS

TECHNICAL TEXTILES CAMIRA. 100% Natural

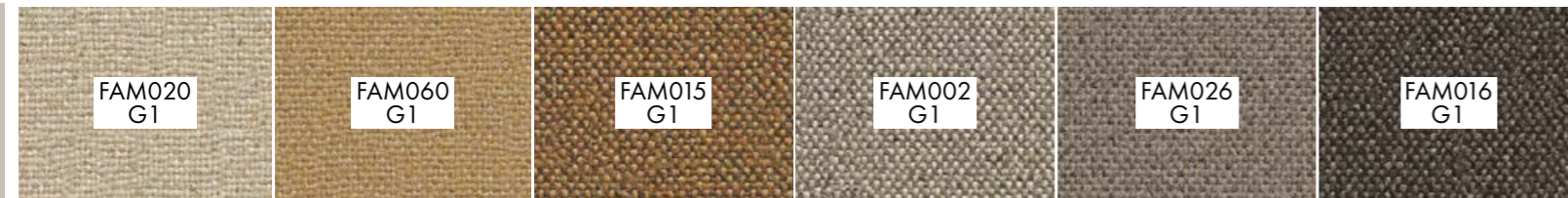

TECHNICAL TEXTILES KVADRAT. Classics

Remix is not valid for chairs



TECHNICAL TEXTILES VESCOM. Recycled



TECHNICAL TEXTILES VESCOM. Recycled



ARTIFICIAL LEATHER

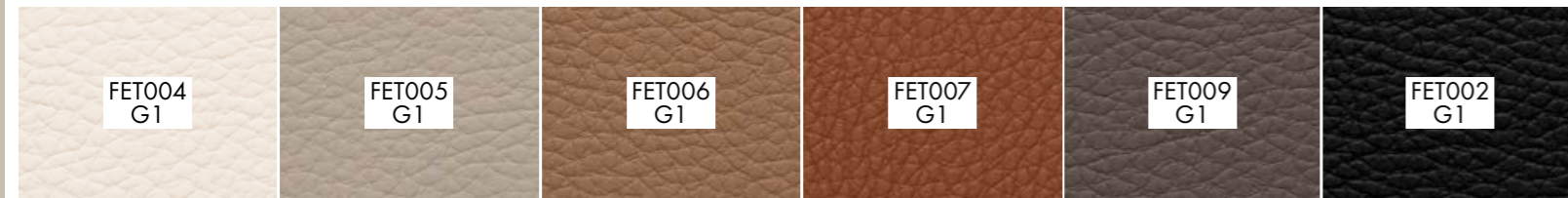

LEATHER NATURAL PROTECTED

LEATHER NATURAL SOFT TOUCH



SOFT TOUCH TEXTILES - Light

SOFT TOUCH TEXTILES - Warm



SOFT FABRICS THAT CAN BE USED ON GAS

THEY ARE SOFA-TYPE FABRICS AND THEREFORE LESS RECOMMENDED FOR CHAIRS

SOFT TOUCH TEXTILES - Cool

SOFT TOUCH TEXTILES - Grey



GAS : UPHOLSTERED

WITHOUT ARMS

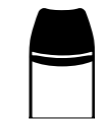

SIDECHAIR



SELF-RETURN WITHOUT ARMS
Fixed height



TASK CHAIR WITHOUT ARMS
Adjustable height

SEAT & BACK	FRAME FINISH	CODE	RETAIL	CODE	RETAIL	CODE	RETAIL
FABRIC GROUP 1	BLACK	82 F-- --	734 \$	82 A F-- --	1278 \$	82 R F-- --	1278 \$
	WHITE	84 F-- --	734 \$	84 A F-- --	1278 \$	84 R F-- --	1278 \$
	SHINY CHROME	80 F-- --	842 \$	80 A F-- --	1386 \$	80 R F-- --	1386 \$
FABRIC GROUP 2	BLACK	82 F-- --	824 \$	82 A F-- --	1368 \$	82 R F-- --	1368 \$
	WHITE	84 F-- --	824 \$	84 A F-- --	1368 \$	84 R F-- --	1368 \$
	SHINY CHROME	80 F-- --	932 \$	80 A F-- --	1476 \$	80 R F-- --	1476 \$
FABRIC GROUP 3	BLACK	82 F-- --	914 \$	82 A F-- --	1458 \$	82 R F-- --	1458 \$
	WHITE	84 F-- --	914 \$	84 A F-- --	1458 \$	84 R F-- --	1458 \$
	SHINY CHROME	80 F-- --	1022 \$	80 A F-- --	1566 \$	80 R F-- --	1566 \$
FABRIC GROUP 4	BLACK	82 F-- --	1049 \$	82 A F-- --	1593 \$	82 R F-- --	1593 \$
	WHITE	84 F-- --	1049 \$	84 A F-- --	1593 \$	84 R F-- --	1593 \$
	SHINY CHROME	80 F-- --	1157 \$	80 A F-- --	1701 \$	80 R F-- --	1701 \$
COM	BLACK	82 COM	734 \$	82 A COM	1278 \$	82 R COM	1278 \$
	WHITE	84 COM	734 \$	84 A COM	1278 \$	84 R COM	1278 \$
	SHINY CHROME	80 COM	842 \$	80 A COM	1386 \$	80 R COM	1386 \$

+T: WITH FELT GLIDES

WITH ARMS



ARMCHAIR



SELF-RETURN WITH ARMS
Fixed height



TASK CHAIR WITH ARMS
Adjustable height

SEAT & BACK	FRAME FINISH	CODE	RETAIL	CODE	RETAIL	CODE	RETAIL
FABRIC GROUP 1	BLACK	82 B F-- --	891 \$	82 BA F-- --	1435 \$	82 BR F-- --	1435 \$
	WHITE	84 B F-- --	891 \$	84 BA F-- --	1435 \$	84 BR F-- --	1435 \$
	SHINY CHROME	80 B F-- --	999 \$	80 BA F-- --	1543 \$	80 BR F-- --	1543 \$
FABRIC GROUP 2	BLACK	82 B F-- --	981 \$	82 BA F-- --	1525 \$	82 BR F-- --	1525 \$
	WHITE	84 B F-- --	981 \$	84 BA F-- --	1525 \$	84 BR F-- --	1525 \$
	SHINY CHROME	80 B F-- --	1089 \$	80 BA F-- --	1633 \$	80 BR F-- --	1633 \$
FABRIC GROUP 3	BLACK	82 B F-- --	1071 \$	82 BA F-- --	1615 \$	82 BR F-- --	1615 \$
	WHITE	84 B F-- --	1071 \$	84 BA F-- --	1615 \$	84 BR F-- --	1615 \$
	SHINY CHROME	80 B F-- --	1179 \$	80 BA F-- --	1723 \$	80 BR F-- --	1723 \$
FABRIC GROUP 4	BLACK	82 B F-- --	1206 \$	82 BA F-- --	1750 \$	82 BR F-- --	1750 \$
	WHITE	84 B F-- --	1206 \$	84 BA F-- --	1750 \$	84 BR F-- --	1750 \$
	SHINY CHROME	80 B F-- --	1314 \$	80 BA F-- --	1858 \$	80 BR F-- --	1858 \$
COM	BLACK	82 B COM	891 \$	82 BA COM	1435 \$	82 BR COM	1435 \$
	WHITE	84 B COM	891 \$	84 BA COM	1435 \$	84 BR COM	1435 \$
	SHINY CHROME	80 B COM	999 \$	80 BA COM	1543 \$	80 BR COM	1543 \$

GAS ARE SHIPPED WITHIN 3 WEEK

+T: WITH FELT GLIDES



Gent FFG010



Walnut



Cognac leather FCG003



Oak



FAST DELIVERY, SHIPS IN ONE WEEK

SEAT & BACK

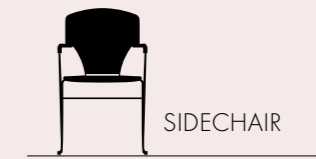
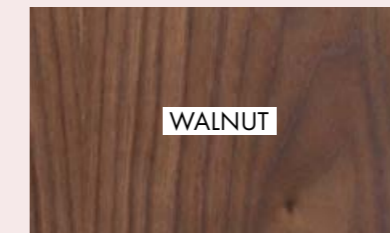

SIDECHAIR

CODE	RETAIL
31W9	756 \$

SEAT & BACK

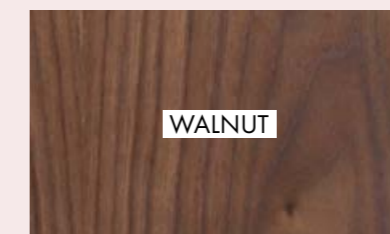

TASK CHAIR

CODE	RETAIL
31W9 R	1242 \$





THESE EGOA ARE SHIPPED WITHIN 1 WEEK
THE REST ARE SHIPPED WITHIN 3 WEEKS



Walnut

EGOA PLYWOOD

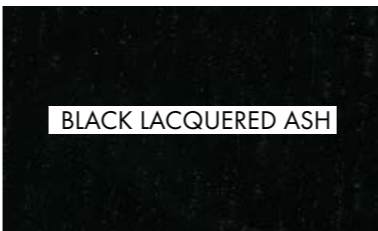

SEAT & BACK	CODE	RETAIL	CODE	RETAIL	FINISH	CODE	RETAIL
 OAK	31W5	738 \$	31W5 R	1224 \$	OAK	535	88 \$
 WARM GREY	3137	738 \$	3137 R	1224 \$	WARM GREY	537	88 \$
 WALNUT	31W9	756 \$	31W9 R	1242 \$	WALNUT	539	95 \$
 ASH	310	738 \$	310 R	1224 \$	ASH	530	88 \$
 WHITE LACQUERED ASH RAL 9010	314	738 \$	314 R	1224 \$	WHITE LACQUERED	534	88 \$
 BLACK LACQUERED ASH	312	738 \$	312 R	1224 \$	BLACK LACQUERED	532	88 \$
					PLASTIC BLACK	528	32 \$

Egoa chair frame: always shiny chrome.

THE EGOA HIGHLIGHTED IN PINK ARE SHIPPED WITHIN 1 WEEK
THE REST ARE SHIPPED WITHIN 3 WEEKS

EGOA UPHOLSTERED

ALL AVAILABLE FABRICS

TECHNICAL TEXTILES CAMIRA. 100% Natural

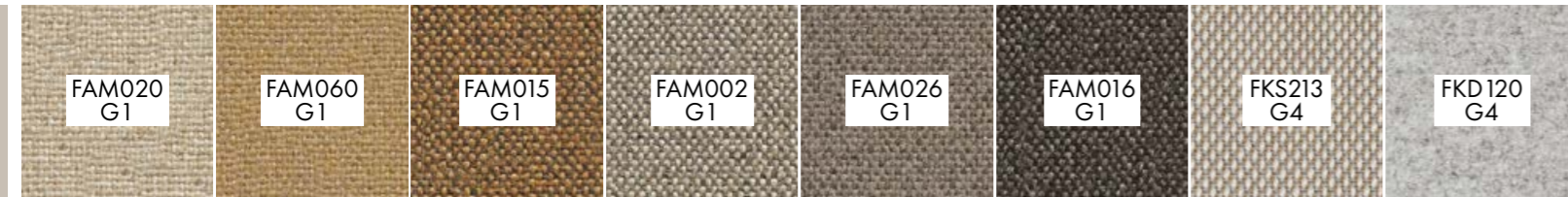

TECH. TEXTILES KVADRAT. Classics

Remix is not valid for chairs

TECHNICAL TEXTILES VESCOM. Recycled



ARTIFICIAL LEATHER

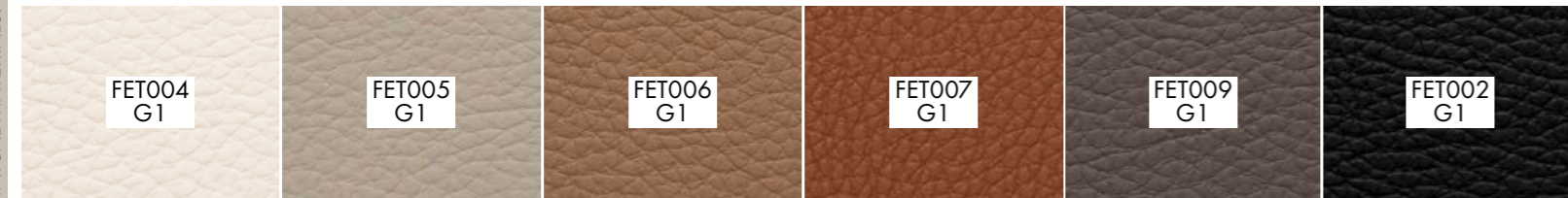

LEATHER NATURAL PROTECTED



LEATHER NATURAL SOFT TOUCH

SOFT TOUCH TEXTILES - Light



SOFT TOUCH TEXTILES - Warm

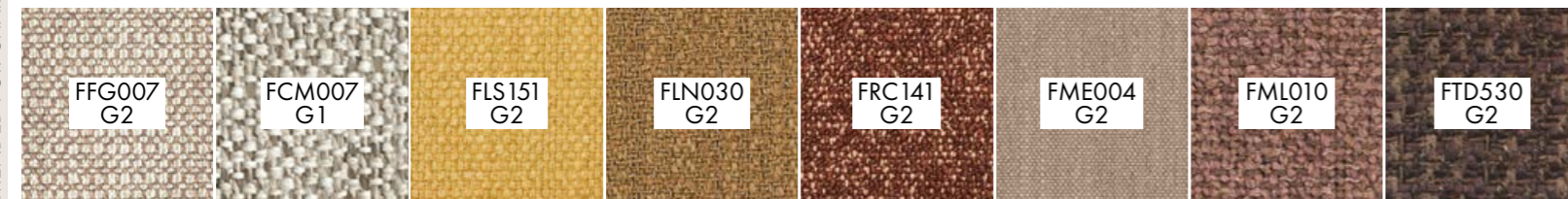

SOFT TOUCH TEXTILES - Cool

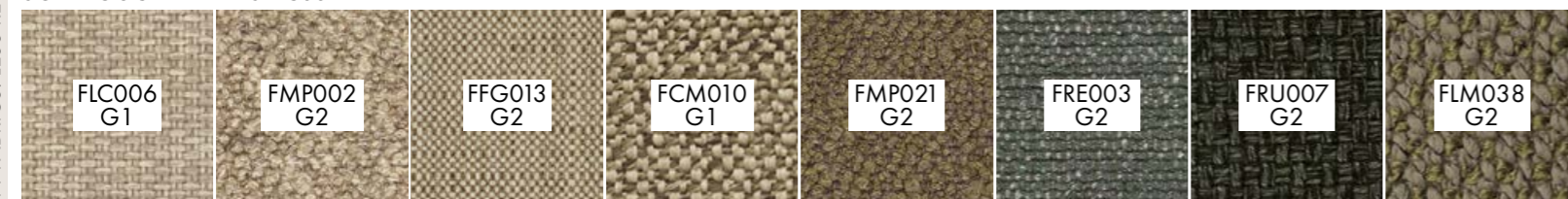

SOFT TOUCH TEXTILES - Grey



TECHNICAL MATERIALS: RECOMMENDED FOR CHAIRS

SOFT FABRICS: LESS RECOMMENDED FOR CHAIRS

EGOA UPHOLSTERED



SIDECHAIR



ARMCHAIR



SET OF 2 ARMS (optional)

SEAT & BACK	CODE	RETAIL	CODE	RETAIL	FINISH	CODE	RETAIL
FABRIC GROUP 1	317 T F-- ---	936 \$	317 RT F-- ---	1422 \$	OAK	535	88 \$
FABRIC GROUP 2	317 T F-- ---	1026 \$	317 RT F-- ---	1512 \$	WARM GREY	537	88 \$
FABRIC GROUP 3	317 T F-- ---	1116 \$	317 RT F-- ---	1602 \$	WALNUT	539	95 \$
FABRIC GROUP 4	317 T F-- ---	1242 \$	317 RT F-- ---	1728 \$	ASH	530	88 \$
COM FABRIC	317 T COM	936 \$	317 RT COM	1422 \$	WHITE LACQUERED	534	88 \$
					BLACK LACQUERED	532	88 \$
					BLACK PLASTIC	528	32 \$

EGOA ARE SHIPPED WITHIN 3 WEEK

LACLASICA



Stained in warm grey



Upholstered seat



Black armchair



White stained ash



LACLASICA

FAST DELIVERY, SHIPS IN ONE WEEK

STAINED ASH



SIDECHAIR



WARM GREY

Mat. Under seat piece black

CODE	RETAIL
40237	932 \$



BLACK

Satin. Under seat piece black

CODE	RETAIL
40232	932 \$

Laclasica have plastic glides when delivered, and additional felt glides are delivered with each chair

THESE LACLASICA ARE SHIPPED WITHIN 1 WEEK
THE REST ARE SHIPPED WITHIN 3 WEEKS

L A C L A S I C A

UPHOLSTERED SEAT

Code of the upholstered chair = Chair code +AT +fabric code.

UPHOLSTERED SEAT	CODE	RETAIL
G1 fabric upholstery	+AT	+171 \$
G2 fabric upholstery	+AT	+171 \$
G3 fabric upholstery	+AT	+171 \$
Leather or G4 fabric upholstery	+AT G4	+270 \$
COM fabric upholstery	+AT COM	+171 \$



STUA UPHOLSTERY

UPHOLSTERY	SEE PAGES
Fabrics	114 - 119
Artificial leather	120
Leather	121



Black stain Black stain Warm grey stain Walnut stain Oak stain Natural ash White stain

L A C L A S I C A

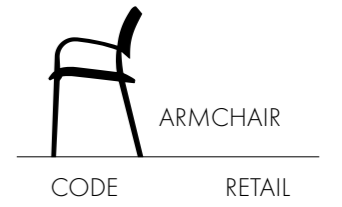
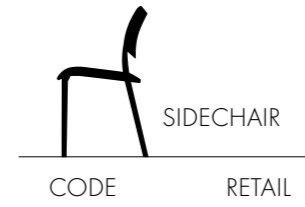

SEAT & BACK

	CODE	RETAIL	CODE	RETAIL
BLACK Satin. Under seat piece black	40232	932 \$	40232 B	1202 \$
WARM GREY Matt. Under seat piece black	40237	932 \$	40237 B	1202 \$
WALNUT TONE Matt. Under seat piece black	40239	932 \$	40239 B	1202 \$
OAK TONE Matt. Under seat piece black	40235	932 \$	40235 B	1202 \$
ASH Matt. Under seat piece white	40400	932 \$	40400 B	1202 \$
WHITE STAINED Matt. Under seat piece white	40434	932 \$	40434 B	1202 \$

O N D A



White frame 68 cm



Black frame 78 cm



Shiny chrome frame 68 cm



Stainless steel frame valid for outdoor use



O N D A

FAST DELIVERY, SHIPS IN ONE WEEK AND AT A BETTER PRICE







FRAME	SEAT		KITCHEN STOOL 68 cm				
	SHELL	RUBBER					
BLACK	BLACK	BLACK	<table border="1"> <thead> <tr> <th>CODE</th> <th>RETAIL</th> </tr> </thead> <tbody> <tr> <td>9622 NE</td> <td>657 \$</td> </tr> </tbody> </table>	CODE	RETAIL	9622 NE	657 \$
CODE	RETAIL						
9622 NE	657 \$						
BLACK	STONE	STONE	<table border="1"> <thead> <tr> <th>CODE</th> <th>RETAIL</th> </tr> </thead> <tbody> <tr> <td>9600 NE</td> <td>657 \$</td> </tr> </tbody> </table>	CODE	RETAIL	9600 NE	657 \$
CODE	RETAIL						
9600 NE	657 \$						
WHITE	WHITE	NO RUBBER	<table border="1"> <thead> <tr> <th>CODE</th> <th>RETAIL</th> </tr> </thead> <tbody> <tr> <td>9644 BL</td> <td>603 \$</td> </tr> </tbody> </table>	CODE	RETAIL	9644 BL	603 \$
CODE	RETAIL						
9644 BL	603 \$						

The fast delivery Onda have plastic glides.

THESE ONDA ARE SHIPPED WITHIN 1 WEEK
THE REST ARE SHIPPED WITHIN 3 WEEKS

O N D A



SHELL	RUBBER		FRAME	CODE	RETAIL	CODE	RETAIL
BLACK	BLACK		BLACK	9622 NE	657 \$	9722 NE	702 \$
			WHITE	9622 BL	666 \$	9722 BL	702 \$
			SHINY CHROME	9622 CB	684 \$	9722 CB	720 \$
			MATT STAINLESS STEEL ▲	9622	435 \$	9722	819 \$
GREEN	GREEN		BLACK	9688 NE	666 \$	9788 NE	702 \$
			WHITE	9688 BL	666 \$	9788 BL	702 \$
			SHINY CHROME	9688 CB	684 \$	9788 CB	720 \$
			MATT STAINLESS STEEL ▲	9688	435 \$	9788	819 \$
TAUPE	TAUPE		BLACK	9633 NE	666 \$	9733 NE	702 \$
			WHITE	9633 BL	666 \$	9733 BL	702 \$
			SHINY CHROME	9633 CB	684 \$	9733 CB	720 \$
			MATT STAINLESS STEEL ▲	9633	435 \$	9733	819 \$
STONE	STONE		BLACK	9600 NE	657 \$	9700 NE	702 \$
			WHITE	9600 BL	666 \$	9700 BL	702 \$
			SHINY CHROME	9600 CB	684 \$	9700 CB	720 \$
			MATT STAINLESS STEEL ▲	9600	435 \$	9700	819 \$
WHITE	TAUPE		BLACK	9643 NE	666 \$	9743 NE	702 \$
			WHITE	9643 BL	666 \$	9743 BL	702 \$
			SHINY CHROME	9643 CB	684 \$	9743 CB	720 \$
			MATT STAINLESS STEEL ▲	9643	435 \$	9743	819 \$
WHITE	NO RUBBER		BLACK	9644 NE	612 \$	9744 NE	648 \$
			WHITE	9644 BL	603 \$	9744 BL	648 \$
			SHINY CHROME	9644 CB	630 \$	9744 CB	666 \$
			MATT STAINLESS STEEL ▲	9644	729 \$	9744	765 \$
			WITH BLACK FELT GLIDES	+T	+36 \$	+T	+36 \$

THE ONDA HIGHLIGHTED IN PINK ARE SHIPPED WITHIN 1 WEEK
THE REST ARE SHIPPED WITHIN 3 WEEKS

PETAL



Oak Ø120 cm



Warm Grey 100 x 240 cm



Walnut 100 x 240 cm

PETAL

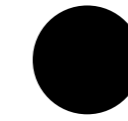

Ø 120 cm

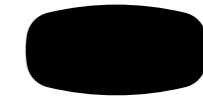

100 x 200 cm

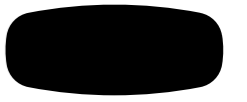

100 x 240 cm

TABLETOP & LEGS

CODE RETAIL

CODE RETAIL

CODE RETAIL



OAK

PE12W5 1640 \$

PE1020W5 2167 \$

PE1024W5 2221 \$



WARM GREY

PE1237 1640 \$

PE102037 2167 \$

PE102437 2221 \$

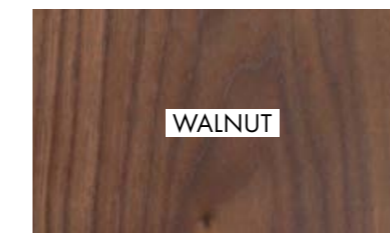

WALNUT

PE12W9 1912 \$

PE1020W9 2603 \$

PE1024W9 2678 \$

THE PETAL TABLES HIGHLIGHTED IN PINK ARE SHIPPED WITHIN 1 WEEK
THE REST ARE SHIPPED WITHIN 3 WEEKS

DIMENSIONS

Thickness of legs and beams: 3 cm

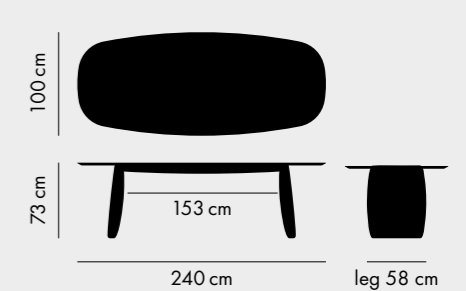
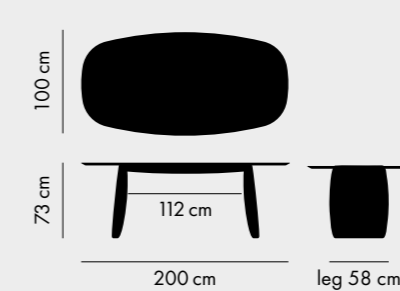
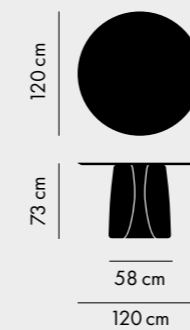

DIMENSIONS UNDER TABLETOP

39

35

18

38

16

35

18

38

18



PETAL XL



Stained warm grey, 100 x 320 cm



Oak, 100 x 480 cm



Stained warm grey, 100 x 400 cm

PETAL XL

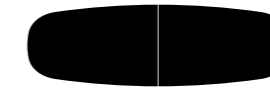

100 x 320 cm

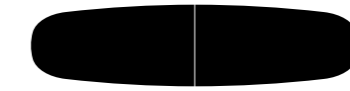

100 x 400 cm

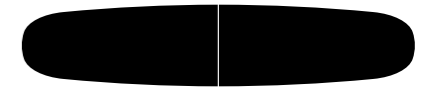

100 x 480 cm

TABLETOP & LEGS

CODE

RETAIL

CODE

RETAIL

CODE

RETAIL



OAK

PE1032W5

3823 \$

PE1040W5

4883 \$

PE1048W5

5000 \$



WARM GREY

PE103237

3823 \$

PE104037

4883 \$

PE104837

5000 \$

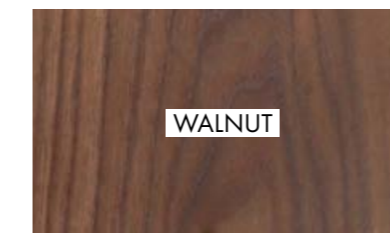

WALNUT

PE1032W9

4687 \$

PE1040W9

5783 \$

PE1048W9

5918 \$

THE PETAL XL ARE SHIPPED IN 6-7 WEEKS

TWO PARTS. These large-format tabletops are made up of two pieces joined together with a concealed joint system.
DIFFERENT PATTERNS. As this is a natural wood finish, it is not possible to guarantee the homogeneity of the wood pattern between the two parts.
BLACK. For contract work it can be made in black laminate. Ask us for a quote.
SPECIAL WIDTH 120 CM. Petal XL can be manufactured in a width of 120 cm, with a surcharge of \$495.

DIMENSIONS

Thickness of legs and beams: 3 cm

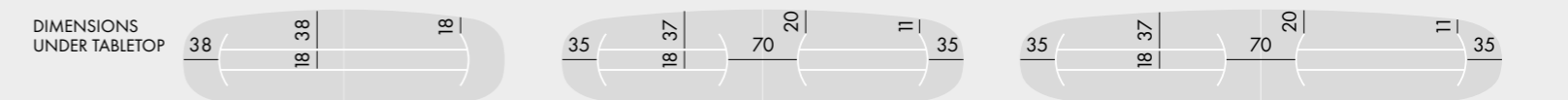
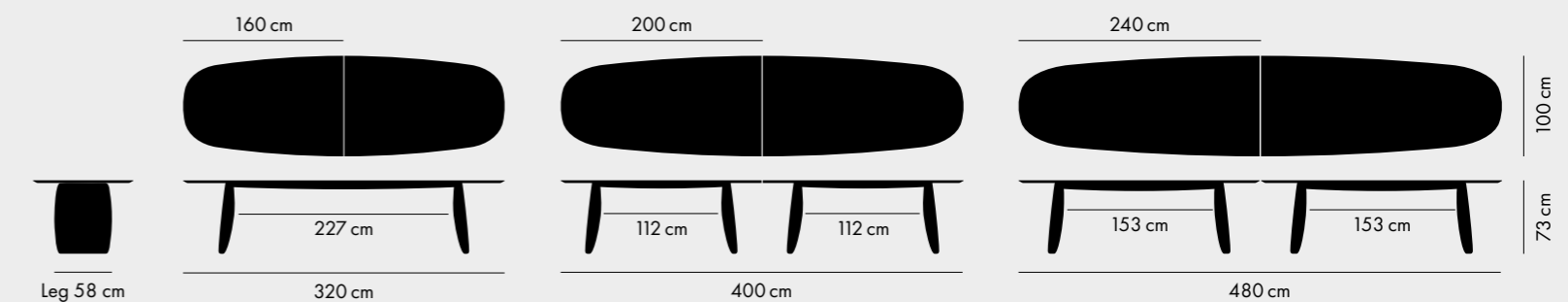

TALL PETAL



Oak Ø100 cm



Oak Ø 80 cm



Oak 100 x 240 cm

TALL PETAL 100 CM



80 cm



100 cm

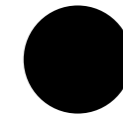

120 cm

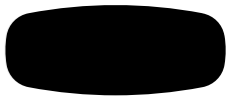

100 x 240 cm

TABLETOP & LEGS

CODE

RETAIL

CODE

RETAIL

CODE

RETAIL

CODE

RETAIL



OAK

PEA80W5

2722 \$

PEA10W5

2939 \$

PEA12W5

3028 \$

PEA1024W5 6055 \$



WARM GREY

PEA8037

2722 \$

PEA1037

2939 \$

PEA1237

3028 \$

PEA102437 6055 \$

THE TALL PETAL ARE SHIPPED IN 6-7 WEEKS

DIMENSIONS

Thickness of legs and beams: 3 cm

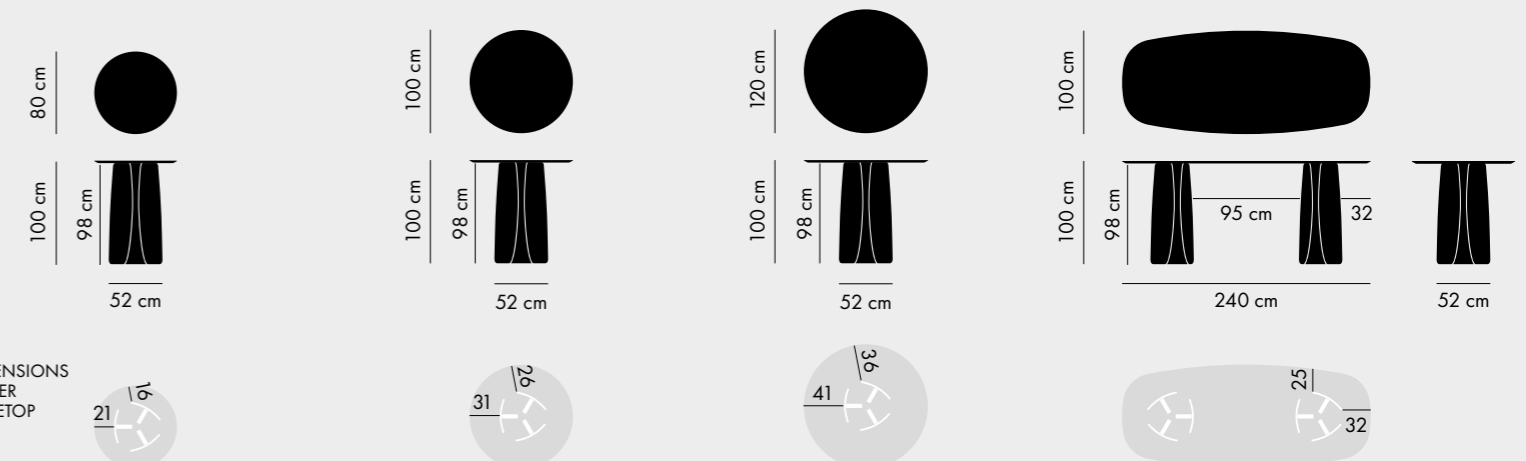

D E N E B



Console 40 x 120 cm



Table 90 x 160 cm



Teak table 90 x 180 and benches 40 x 160 cm



White Deneb



D E N E B

FAST DELIVERY, SHIPS IN ONE WEEK

TABLETOP

FRAME

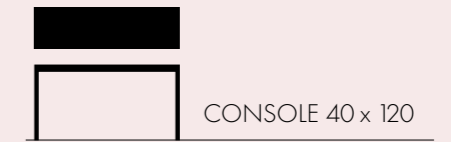

CONSOLE 40 x 120



BLACK LAMINATE

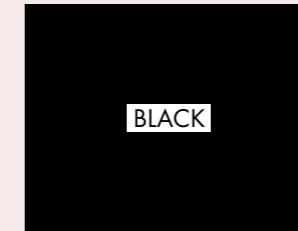

BLACK

CODE
D2412A2

RETAIL
1098 \$

TABLETOP

FRAME



TABLE 90 x 160 cm

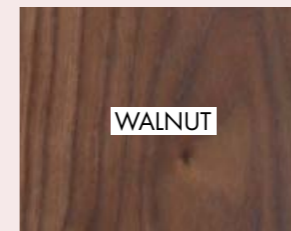

WALNUT

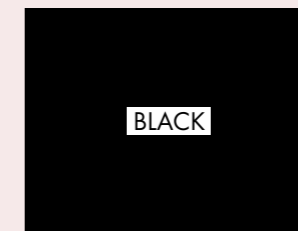

BLACK

CODE
C9169 + D29167

RETAIL
3019 \$



THESE DENE B TABLES ARE SHIPPED WITHIN 1 WEEK
THE REST ARE SHIPPED WITHIN 3 WEEKS

DENE B I N D O O R

TABLES, H 73

THESE PRICES ARE FOR THE WHOLE TABLE

CONSOLE

TABLETOPS	FRAME	90 x 160 cm		90 x 180 cm		90 x 200 cm		90 x 240 cm		40x120 cm	
		CODE	RETAIL	CODE	RETAIL	CODE	RETAIL	CODE	RETAIL	CODE	RETAIL
 BLACK LAMINATE	BLACK	C916A2 + D29167	2864 \$	C918A2 + D29187	3078 \$	C920A2 + D29207	3382 \$	C924A2 + D29247	3897 \$	D2412A2	1098 \$
	WHITE	C916A2 + D49167	2864 \$	C918A2 + D49187	3078 \$	C920A2 + D49207	3382 \$	C924A2 + D49247	3897 \$		
 OAK	BLACK	C916W5 + D29167	2983 \$	C918W5 + D29187	3209 \$	C920W5 + D29207	3526 \$	C924W5 + D29247	4064 \$		
	WHITE	C916W5 + D49167	2983 \$	C918W5 + D49187	3209 \$	C920W5 + D49207	3526 \$	C924W5 + D49247	4064 \$		
 WARM GREY	BLACK	C91637 + D29167	2983 \$	C91837 + D29187	3209 \$	C92037 + D29207	3526 \$	C92437 + D29247	4064 \$		
	WHITE	C91637 + D49167	2983 \$	C91837 + D49187	3209 \$	C92037 + D49207	3526 \$	C92437 + D49247	4064 \$		
 WALNUT	BLACK	C916W9 + D29167	3019 \$	C918W9 + D29187	3245 \$	C920W9 + D29207	3571 \$	C924W9 + D29247	4118 \$		
	WHITE	C916W9 + D49167	3019 \$	C918W9 + D49187	3245 \$	C920W9 + D49207	3571 \$	C924W9 + D49247	4118 \$		
 WHITE HPL with black edge	BLACK	C9164 + D29167	2983 \$	C9184 + D29187	3209 \$	C9204 + D29207	3526 \$	C9244 + D29247	4064 \$		
	WHITE	C9164 + D49167	2983 \$	C9184 + D49187	3209 \$	C9204 + D49207	3526 \$	C9244 + D49247	4064 \$		

THE DENE B TABLES HIGHLIGHTED IN PINK ARE SHIPPED WITHIN 1 WEEK
THE REST ARE SHIPPED WITHIN 3 WEEKS

DENE B O U T D O O R

BENCHES, H 44cm

THESE PRICES ARE FOR THE WHOLE BENCH

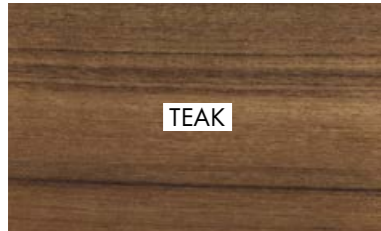
OUTDOOR TABLETOPS	FRAME	40 x 140 cm		40 x 160 cm		40 x 180 cm	
		CODE	RETAIL	CODE	RETAIL	CODE	RETAIL
 <p>WHITE HPL with black edge</p>	BLACK	ON REQUEST		ON REQUEST		ON REQUEST	
	WHITE	D44144	1314 \$	D44164	1462 \$	D44184	1535 \$
 <p>TEAK</p>	BLACK	T24145	2561 \$	T24165	2740 \$	T24185	2867 \$
	WHITE	T44145	2561 \$	T44165	2740 \$	T44185	2867 \$

TABLES, H 73cm

THESE PRICES ARE FOR THE WHOLE TABLE

90 x 160 cm		90 x 180 cm		90 x 200 cm		90 x 240 cm	
CODE	RETAIL	CODE	RETAIL	CODE	RETAIL	CODE	RETAIL
C9164 + D29167	2983 \$	C9184 + D29187	3209 \$	C9204 + D29207	3526 \$	C9244 + D29247	4064 \$
C9164 + D49167	2983 \$	C9184 + D49187	3209 \$	C9204 + D49207	3526 \$	C9244 + D49247	4064 \$
T2916 + D29167	3947 \$	T2918 + D29187	4302 \$	T2920 + D29207	4702 \$	<p>The design of the Deneb table does not allow for a 240 cm teak top.</p>	
T4916 + D49167	3947 \$	T4918 + D49187	4302 \$	T4920 + D49207	4702 \$		

ACCESSORIES

TEAK SLAT WITH HOLE



Teak tables include, free of charge, an extra slat with a Ø50 mm central hole. This slat can replace the central slat so that a parasol can be placed in it.

FLOOR FIXING SYSTEM



FIXING PIECES	CODE	RETAIL
Set of 4 for 1 table	DFIX	169 \$

Deneb tables and benches can be fixed to the floor by means of four special aluminium pieces that replace the plastic caps.

Important: please ask for the fixing system when ordering the table or bench so that it can be delivered already installed on the legs.

ZERO



ZERO

FAST DELIVERY, SHIPS IN ONE WEEK

TABLETOP



BASE

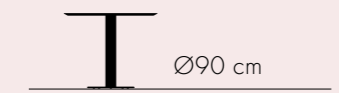
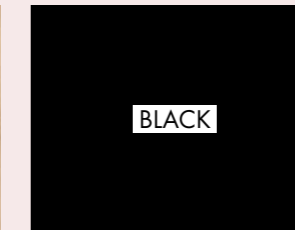

CODE

Z9W5 + 3245

RETAIL





1571 \$

THIS ZERO TABLE IS SHIPPED WITHIN ONE WEEK

ZERO ROUND

TABLES

THESE PRICES ARE FOR THE COMPLETE TABLE

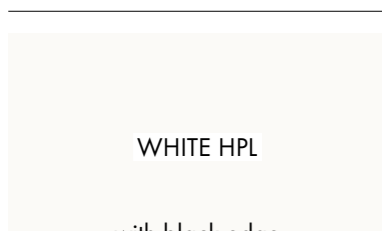





TABLETOPS	BASE	 Ø 80 cm with Ø 45 cm base		 Ø 90 cm with Ø 45 cm base		 Ø 100 cm with Ø 45 cm base		 Ø 110 cm with Ø 55 cm base		 Ø 120 cm with Ø 55 cm base	
		CODE	RETAIL	CODE	RETAIL	CODE	RETAIL	CODE	RETAIL	CODE	RETAIL
 BLACK LAMINATE	BLACK (RAL 9011)	Z8A2 + 3245	1445 \$	Z9A2 + 3245	1532 \$	Z10A2 + 3245	1600 \$	Z11A2 + 3255	1755 \$	Z12A2 + 3255	1858 \$
	WHITE (RAL 9010)	Z8A2 + 3445	1445 \$	Z9A2 + 3445	1532 \$	Z10A2 + 3445	1600 \$	Z11A2 + 3455	1755 \$	Z12A2 + 3455	1858 \$
	STAINLESS STEEL	Z8A2 + 3045I	1661 \$	Z9A2 + 3045I	1748 \$	Z10A2 + 3045I	1009 \$	Z11A2 + 3055I	2097 \$	Z12A2 + 3055I	2200 \$
 OAK	BLACK	Z8W5 + 3245	1480 \$	Z9W5 + 3245	1571 \$	Z10W5 + 3245	1647 \$	Z11W5 + 3255	1798 \$	Z12W5 + 3255	1908 \$
	WHITE	Z8W5 + 3445	1480 \$	Z9W5 + 3445	1571 \$	Z10W5 + 3445	1647 \$	Z11W5 + 3455	1798 \$	Z12W5 + 3455	1908 \$
	STAINLESS STEEL	Z8W5 + 3045I	1696 \$	Z9W5 + 3045I	1787 \$	Z10W5 + 3045I	1863 \$	Z11W5 + 3055I	2140 \$	Z12W5 + 3055I	2250 \$
 WARM GREY	BLACK	Z837 + 3245	1480 \$	Z937 + 3245	1571 \$	Z1037 + 3245	1647 \$	Z1137 + 3255	1798 \$	Z1237 + 3255	1908 \$
	WHITE	Z837 + 3445	1480 \$	Z937 + 3445	1571 \$	Z1037 + 3445	1647 \$	Z1137 + 3455	1798 \$	Z1237 + 3455	1908 \$
	STAINLESS STEEL	Z837 + 3045I	1696 \$	Z937 + 3045I	1787 \$	Z1037 + 3045I	1863 \$	Z1137 + 3055I	2140 \$	Z1237 + 3055I	2250 \$
 WALNUT	BLACK	Z8W9 + 3245	1512 \$	Z9W9 + 3245	1624 \$	Z10W9 + 3245	1708 \$	Z11W9 + 3255	1868 \$	Z12W9 + 3255	1960 \$
	WHITE	Z8W9 + 3445	1512 \$	Z9W9 + 3445	1624 \$	Z10W9 + 3445	1708 \$	Z11W9 + 3455	1868 \$	Z12W9 + 3455	1960 \$
	STAINLESS STEEL	Z8W9 + 3045I	1728 \$	Z9W9 + 3045I	1840 \$	Z10W9 + 3045I	1924 \$	Z11W9 + 3055I	2210 \$	Z12W9 + 3055I	2302 \$
 WHITE LACQUERED RAL 9010	BLACK	Z84 + 3245	1480 \$	Z94 + 3245	1571 \$	Z104 + 3245	1647 \$	Z114 + 3255	1798 \$	Z124 + 3255	1908 \$
	WHITE	Z84 + 3445	1480 \$	Z94 + 3445	1571 \$	Z104 + 3445	1647 \$	Z114 + 3455	1798 \$	Z124 + 3455	1908 \$
	STAINLESS STEEL	Z84 + 3045I	1696 \$	Z94 + 3045I	1787 \$	Z104 + 3045I	1863 \$	Z114 + 3055I	2140 \$	Z124 + 3055I	2250 \$
 WHITE HPL with black edge	BLACK	Z84C + 3245	1480 \$	Z94C + 3245	1571 \$	Z104C + 3245	1647 \$	Z114C + 3255	1798 \$	Z124C + 3255	1908 \$
	WHITE	Z84C + 3445	1480 \$	Z94C + 3445	1571 \$	Z104C + 3445	1647 \$	Z114C + 3455	1798 \$	Z124C + 3455	1908 \$
	STAINLESS STEEL ▲▲	Z84C + 3045I	1696 \$	Z94C + 3045I	1787 \$	Z104C + 3045I	1863 \$	Z114C + 3055I	2140 \$	Z124C + 3055I	2250 \$

THE ZERO TABLE HIGHLIGHTED IN PINK IS SHIPPED WITHIN 1 WEEK
THE REST ARE SHIPPED WITHIN 3 WEEKS

ZERO FOR HOSPITALITY

TABLES

THESE PRICES ARE FOR THE COMPLETE TABLE

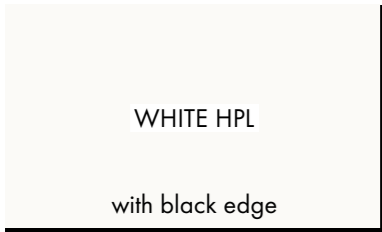
TABLETOPS	BASE	 Ø 60 cm with Ø 45 cm base		 60 x 60 cm with Ø 45 cm base		 70 x 70 cm with Ø 45 cm base		 80 x 80 cm with Ø 45 cm base		 90 x 90 cm with Ø 45 cm base	
		CODE	RETAIL	CODE	RETAIL	CODE	RETAIL	CODE	RETAIL	CODE	RETAIL
 BLACK LAMINATE	BLACK (RAL 9011)	Z6A2 + 3245	1210 \$	Z6A2S + 3245	1210 \$	Z7A2S + 3245	1352 \$	Z8A2S + 3255	1445 \$	Z9A2S + 3255	1532 \$
	WHITE (RAL 9010)	Z6A2 + 3445	1210 \$	Z6A2S + 3445	1210 \$	Z7A2S + 3445	1352 \$	Z8A2S + 3455	1445 \$	Z9A2S + 3455	1532 \$
	STAINLESS STEEL	Z6A2 + 3045I	1426 \$	Z6A2S + 3045I	1426 \$	Z7A2S + 3045I	1568 \$	Z8A2S + 3055I	1661 \$	Z9A2S + 3055I	1748 \$
 WHITE HPL with black edge	BLACK	Z64C + 3245	1231 \$	Z64CS + 3245	1231 \$	Z74CS + 3245	1384 \$	Z84CS + 3255	1480 \$	Z94CS + 3255	1571 \$
	WHITE	Z64C + 3445	1231 \$	Z64CS + 3445	1231 \$	Z74CS + 3445	1384 \$	Z84CS + 3455	1480 \$	Z94CS + 3455	1571 \$
	STAINLESS STEEL ▲▲	Z64C + 3045I	1447 \$	Z64CS + 3045I	1447 \$	Z74CS + 3045I	1600 \$	Z84CS + 3055I	1696 \$	Z94CS + 3055I	1787 \$

▲▲ Dimensions in HPL, 1 cm smaller than indicated.

THESE ZERO TABLES ARE SHIPPED WITHIN 3 WEEKS



Black 80 x 80 cm



Warm grey stained 100 x 240 cm



Natural ash Ø120 cm



Console 40 x 110 cm

FAST DELIVERY, SHIPS IN ONE WEEK

CONSOLE

40 x 110 cm



BLACK LAMINATE

CODE	RETAIL
X411A2 + L7332	1242 \$

DESK

60 x 120 cm



BLACK LAMINATE

CODE	RETAIL
X612A2 + L7332	1350 \$

TABLE

Ø100 cm



WARM GREY

CODE	RETAIL
X1037 + L7337	1697 \$

THESE LAU TABLES ARE SHIPPED WITHIN A WEEK



LAU

TABLES

CONSOLE & DESK

SQUARE

RECTANGULAR

ROUND

	40 x 110 cm		60 x 120 cm		80 x 80 cm		90 x 180 cm		100 x 240 cm		Ø 100 cm		Ø 120 cm	
	CODE	RETAIL	CODE	RETAIL	CODE	RETAIL	CODE	RETAIL	CODE	RETAIL	CODE	RETAIL	CODE	RETAIL
	X411A2 + L7332	1242 \$	X612A2 + L7332	1350 \$	X88A2 + L7332	1350 \$	X918A2	3458 \$	X124A2	3942 \$	X10A2 + L7332	1525 \$	X12A2 + L7332	1732 \$
	X41137 + L7337	1260 \$	X61237 + L7337	1422 \$			X91837	3838 \$	X12437	4374 \$	X1037 + L7337	1697 \$	X1237 + L7337	1935 \$
	X41139 + L7339	1260 \$	X61239 + L7339	1422 \$			X91839	3838 \$	X12439	4374 \$	X1039 + L7339	1697 \$	X1239 + L7339	1935 \$
	X41135 + L7335	1260 \$	X61235 + L7335	1422 \$			X91835	3838 \$	X12435	4374 \$	X1035 + L7335	1697 \$	X1235 + L7335	1935 \$
	X41130 + L7330	1260 \$	X61230 + L7330	1422 \$			X91830	3838 \$	X12430	4374 \$	X1030 + L733	1697 \$	X1230 + L7330	1935 \$
	X41134 + L7334	1260 \$	X61234 + L7334	1422 \$			X91834	3838 \$	X12434	4374 \$	X1034 + L7334	1697 \$	X1234 + L7334	1935 \$

THE LAU TABLES HIGHLIGHTED IN PINK ARE SHIPPED WITHIN 1 WEEK
THE REST ARE SHIPPED WITHIN 3 WEEKS

The tabletops and legs of these tables can be combined
in different finishes.

These large tables have a metal reinforcement under the top, hidden
by wooden frame. Tabletop and legs always in the same finish.

The tabletops and legs of these tables can be combined
in different finishes.

M A R E A



Heights 40 and 55 cm. Black laminate Ø60 and 70



Height 55 cm. Walnut Ø60 cm



Height 40 cm. Walnut Ø60 cm

M A R E A

PRICE = TABLETOP + LEGS



Ø 60 cm



Ø 70 cm



Ø 80 cm

TABLETOPS



BLACK LAMINATE

CODE RETAIL

M6A2 257 \$

CODE RETAIL

M7A2 427 \$

CODE RETAIL

M8A2 538 \$

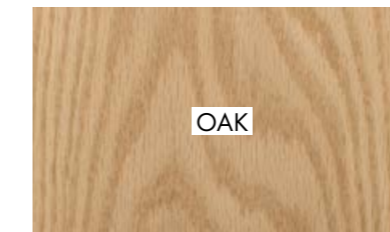

OAK

M6W5 349 \$

M7W5 500 \$

M8W5 610 \$



WALNUT

M6W9 367 \$

M7W9 527 \$

M8W9 630 \$



HEIGHT 40 cm



HEIGHT 55 cm

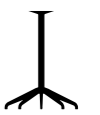

HEIGHT 73 cm

BASES

CODE RETAIL

INF62-40 455 \$

CODE RETAIL

INF62-55 500 \$

CODE RETAIL

INF62-73 553 \$

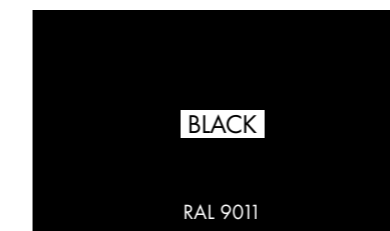

BLACK

RAL 9011

The white and chrome bases have been discontinued. STUA still has units of these bases available at the same price as the black ones. Contact us.

THE MAREA TABLE HIGHLIGHTED IN PINK IS SHIPPED WITHIN 1 WEEK
THE REST ARE SHIPPED WITHIN 3 WEEKS

S O L A P A



S O L A P A

PRICE = TABLETOP + LEGS



58 x 58 cm



38 x 118 cm





58 x 118 cm



118 x 118 cm

TABLETOPS

	58 x 58 cm		38 x 118 cm		58 x 118 cm		118 x 118 cm	
	CODE	RETAIL	CODE	RETAIL	CODE	RETAIL	CODE	RETAIL
	S66W5	232 \$	S412W5	302 \$	S612W5	457 \$	S1212W5	914 \$
	S66W9	243 \$	S412W9	319 \$	S612W9	481 \$	S1212W9	959 \$
	S66F2	441 \$	S412F2	522 \$	S612F2	819 \$	S1212F2	1818 \$

LEGS, BOX WITH 4

	HEIGHT 30 cm		HEIGHT 36 cm	
	CODE	RETAIL	CODE	RETAIL
	S32	171 \$	S42	202 \$

Each tabletop can be fitted with either of the two leg options.

THE SOLAPA TABLES HIGHLIGHTED IN PINK ARE SHIPPED WITHIN 1 WEEK
THE REST ARE SHIPPED WITHIN 3 WEEKS

ECLIPSE

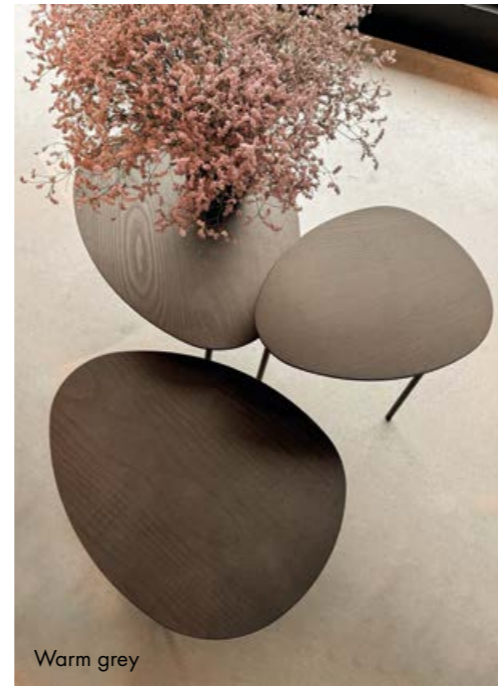

ECLIPSE

PRICE = TABLETOP + LEGS



SMALL
37 x 46 cm



MEDIUM
44 x 55 cm



LARGE
56 x 71 cm

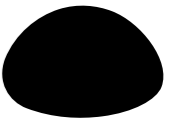

EXTRA LARGE
77 x 111 cm

TABLETOPS



CODE	RETAIL	CODE	RETAIL	CODE	RETAIL	CODE	RETAIL
EC1W5	146 \$	EC2W5	184 \$	EC3W5	250 \$	EC4W5	439 \$



EC1W9	162 \$	EC2W9	202 \$	EC3W9	277 \$	EC4W9	484 \$
-------	--------	-------	--------	-------	--------	-------	--------



EC137	146 \$	EC237	184 \$	EC337	250 \$	EC437	439 \$
-------	--------	-------	--------	-------	--------	-------	--------



EC104	146 \$	EC204	184 \$	EC304	250 \$	EC404	439 \$
-------	--------	-------	--------	-------	--------	-------	--------

LEGS, BOX WITH 3

[[[HEIGHT 20 cm	[[[HEIGHT 25 cm	[[[HEIGHT 30 cm	[[[HEIGHT 35 cm				
EP202	171 \$	EP252	182 \$	EP302	193 \$	EP352	203 \$
EP203	184 \$	EP253	194 \$	EP303	205 \$	EP353	216 \$

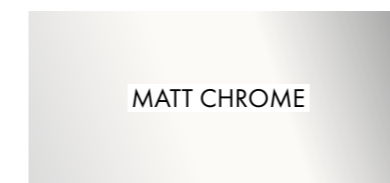

THE ECLIPSE TABLES HIGHLIGHTED IN PINK ARE SHIPPED WITHIN 1 WEEK
THE REST ARE SHIPPED WITHIN 2 WEEKS

MESETA



Oak



Black Fenix



Walnut

MESETA

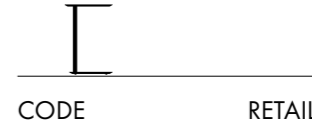

TABLETOP & BASE

	CODE	RETAIL
 <p>OAK</p>	ME6234W5	434 \$
 <p>WALNUT</p>	ME6234W9	455 \$
 <p>BLACK FENIX</p>	ME6234F2	686 \$

ALL THE MESETA TABLES ARE SHIPPED WITHIN 1 WEEK

PAUSA INDOOR



Ø120 cm. H 40 cm.



Ø40 y 60 cm. H 50 y 40 cm.



Ø120 cm. H 40 cm.

PAUSA INDOOR

PRICE = TABLETOP + LEGS



TABLETOPS



BLACK LAMINATE

Ø 40 cm		Ø 60 cm		Ø 80 cm		Ø 120 cm	
CODE	RETAIL	CODE	RETAIL	CODE	RETAIL	CODE	RETAIL
PT40A2	142 \$	PT60A2	225 \$	PT80A2	463 \$	PT120A2	868 \$

LEGS, BOX WITH 3



BLACK STEEL

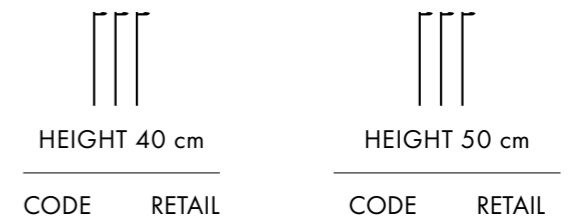

HEIGHT 40 cm		HEIGHT 50 cm	
CODE	RETAIL	CODE	RETAIL
PA402	175 \$	PA502	218 \$

THE PAUSA TABLES HIGHLIGHTED IN PINK ARE SHIPPED WITHIN 1 WEEK
THE REST ARE SHIPPED WITHIN 3 WEEKS

PAUSA OUTDOOR



Ø 40 y 60 cm. H 40 y 50 cm.



Ø 40 cm. H 50 cm.



Ø 40 y 60 cm. H 40 y 50 cm.

PAUSA OUTDOOR

PRICE = TABLETOP + LEGS

TABLETOPS	Ø 40 cm		Ø 60 cm		Ø 80 cm	
	CODE	RETAIL	CODE	RETAIL	CODE	RETAIL
WHITE HPL	PT40K4	259 \$	PT60K4	470 \$	PT80K4	857 \$
BLACK HPL	PT40K2	259 \$	PT60K2	470 \$	PT80K2	857 \$

LEGS, BOX WITH 3	HEIGHT 40 cm		HEIGHT 45 cm		HEIGHT 50 cm	
	CODE	RETAIL	CODE	RETAIL	CODE	RETAIL
WHITE STAINLESS STEEL	PP404	247 \$	PP454	268 \$	PP504	292 \$
BLACK STAINLESS STEEL	PP402	247 \$	PP452	268 \$	PP502	292 \$

THESE PAUSA TABLES ARE SHIPPED WITHIN 3 WEEKS

CALMA

100% REMOVABLE COVER



CALMA

FAST DELIVERY, SHIPS IN ONE WEEK

OUTDOOR FABRICS HIGHLIGHTS



INDOOR FABRICS HIGHLIGHTS

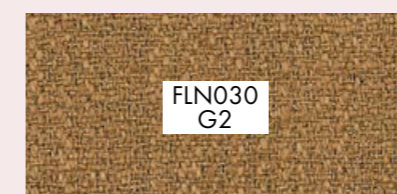
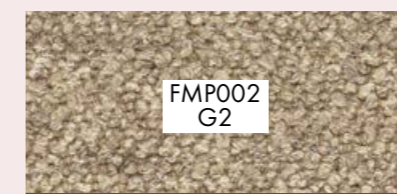
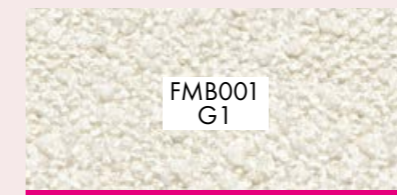

OUTDOOR CALMA
WHITE FRAME & ARMS

CODE	RETAIL
CAB44 FLC006	1345 \$

CODE	RETAIL
CAB44 FLC002	1345 \$

INDOOR CALMA
WHITE FRAME & ARMS

CODE	RETAIL
CAM44 FMB001	1345 \$

CODE	RETAIL
CAM44 FCM007	1345 \$

CODE	RETAIL
CAM44 FMP002	1445 \$

CODE	RETAIL
CAM44 FLN030	1445 \$

OUTDOOR CALMA
BLACK FRAME & ARMS

CODE	RETAIL
CAB22 FLC006	1345 \$

CODE	RETAIL
CAB22 FLC002	1345 \$

INDOOR CALMA
BLACK FRAME & ARMS

CODE	RETAIL
CAM22 FMB001	1345 \$

CODE	RETAIL
CAM22 FCM007	1345 \$

CODE	RETAIL
CAM22 FMP002	1445 \$

CODE	RETAIL
CAM22 FLN030	1445 \$

THESE CALMA ARE SHIPPED WITHIN 1 WEEK
THE REST ARE SHIPPED WITHIN 3 WEEKS

OUTDOOR CALMA



OUTDOOR CALMA

WITH OUTDOOR FRAME AND DRY FEEL FOAM. SIX FABRIC OPTIONS



BLACK FRAME & ARMS



BLACK FRAME

UPHOLSTERY	CODE	RETAIL	CODE	RETAIL
FLC006	CAB22 FLC006	1345 \$	CAR2 FLC006	520 \$
FLC256	CAB22 FLC256	1345 \$	CAR2 FLC256	520 \$
FLC002	CAB22 FLC002	1345 \$	CAR2 FLC002	520 \$
FLC259	CAB22 FLC259	1345 \$	CAR2 FLC259	520 \$
FIK200	CAB22 FIK200	1445 \$	CAR2 FIK200	549 \$
FLM038	CAB22 FLM038	1445 \$	CAR2 FLM038	549 \$



WHITE FRAME & ARMS



WHITE FRAME

UPHOLSTERY	CODE	RETAIL	CODE	RETAIL
FLC006	CAB44 FLC006	1345 \$	CAR4 FLC006	520 \$
FLC256	CAB44 FLC256	1345 \$	CAR4 FLC256	520 \$
FLC002	CAB44 FLC002	1345 \$	CAR4 FLC002	520 \$
FLC259	CAB44 FLC259	1345 \$	CAR4 FLC259	520 \$
FIK200	CAB44 FIK200	1445 \$	CAR4 FIK200	549 \$
FLM038	CAB44 FLM038	1445 \$	CAR4 FLM038	549 \$

THE CALMA ARMCHAIRS HIGHLIGHTED IN PINK ARE SHIPPED WITHIN 1 WEEK
THE REST ARE SHIPPED WITHIN 3 WEEKS

INDOOR CALMA

SOFT TOUCH TEXTILES - Light



SOFT TOUCH TEXTILES - Warm



SOFT TOUCH TEXTILES - Cool

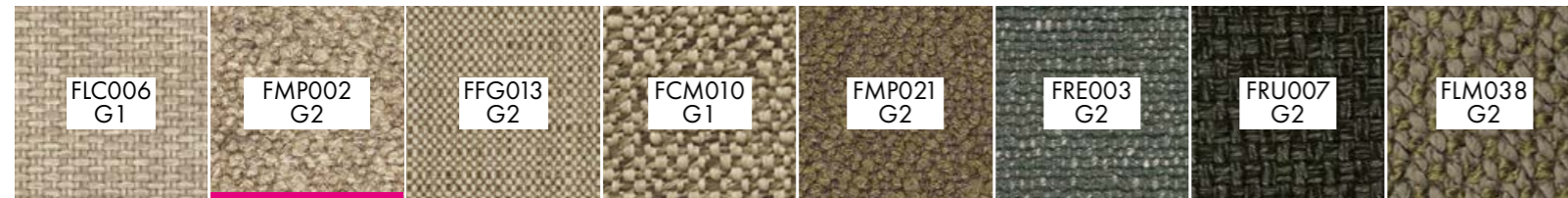

SOFT TOUCH TEXTILES - Grey



TECHNICAL TEXTILES CAMIRA. 100% Natural

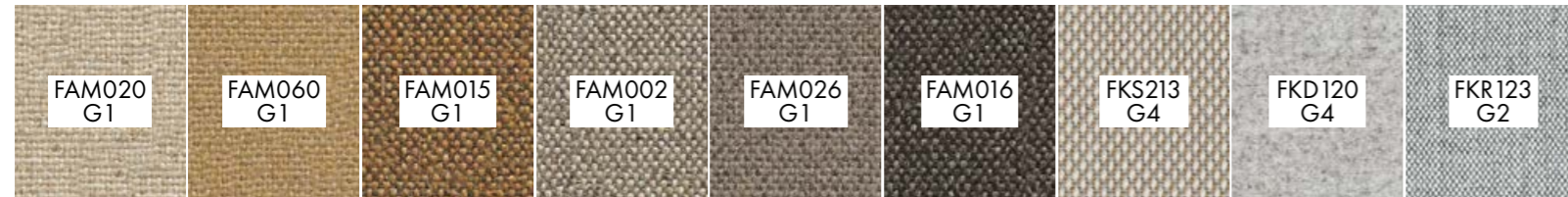

TECHNICAL TEXTILES KVADRAT. Classics

TECHNICAL TEXTILES VESCOM. Recycled



ARTIFICIAL LEATHER

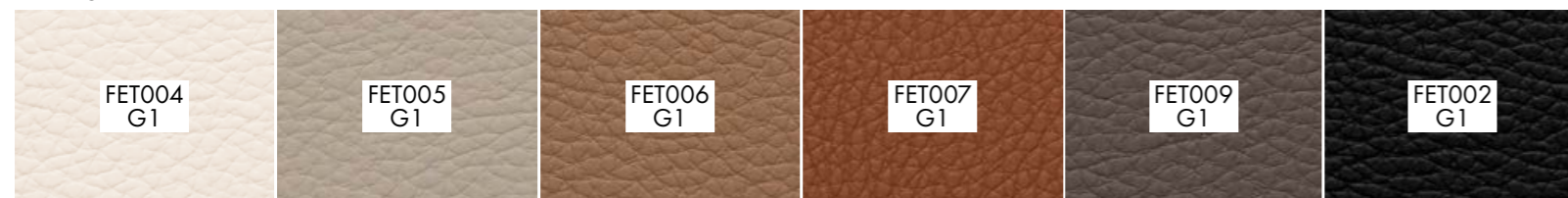

LEATHER NATURAL PROTECTED

LEATHER NATURAL SOFT TOUCH



INDOOR CALMA

WITH INDOOR FRAME AND VISCOELASTIC FOAM. FABRIC OF YOUR CHOICE



ARMCHAIR

BLACK FRAME & ARMS



OTTOMAN

BLACK FRAME

UPHOLSTERY	CODE	RETAIL	CODE	RETAIL
FABRIC GROUP 1	CAM22 F-- ---	1345 \$	CAP2 F-- ---	520 \$
FABRIC GROUP 2	CAM22 F-- ---	1445 \$	CAP2 F-- ---	549 \$
FABRIC GROUP 3	CAM22 F-- ---	1562 \$	CAP2 F-- ---	630 \$
FABRIC GROUP 4	CAM22 F-- ---	1782 \$	CAP2 F-- ---	767 \$
COM	CAM22 COM	1345 \$	CAP2 COM	520 \$



ARMCHAIR

WHITE FRAME & ARMS



OTTOMAN

WHITE FRAME

UPHOLSTERY	CODE	RETAIL	CODE	RETAIL
FABRIC GROUP 1	CAM44 F-- ---	1345 \$	CAP4 F-- ---	520 \$
FABRIC GROUP 2	CAM44 F-- ---	1445 \$	CAP4 F-- ---	549 \$
FABRIC GROUP 3	CAM44 F-- ---	1562 \$	CAP4 F-- ---	630 \$
FABRIC GROUP 4	CAM44 F-- ---	1782 \$	CAP4 F-- ---	767 \$
COM	CAM44 COM	1345 \$	CAP4 COM	520 \$

THE CALMA ARMCHAIRS HIGHLIGHTED IN PINK ARE SHIPPED WITHIN 1 WEEK
THE REST ARE SHIPPED WITHIN 3 WEEKS

NUBE



NUBE

FAST DELIVERY, SHIPS IN ONE WEEK AND AT A BETTER PRICE



CHROMED LEGS



BLACK LEGS

NUBE IN HIGHLIGHT FABRICS



FMB001
HIGHLIGHT



FCM007
HIGHLIGHT



FMP002
HIGHLIGHT



FLN030
HIGHLIGHT

CODE	RETAIL	CODE	RETAIL
N FMB001	2392 \$	N2 FMB001	2392 \$

CODE	RETAIL	CODE	RETAIL
N FCM007	2392 \$	N2 FCM007	2392 \$

CODE	RETAIL	CODE	RETAIL
N FMP002	2392 \$	N2 FMP002	2392 \$

CODE	RETAIL	CODE	RETAIL
N FLN030	2392 \$	N2 FLN030	2392 \$

The Nube seat cover is removable.

THESE NUBE ARE SHIPPED WITHIN 1 WEEK
THE REST ARE SHIPPED WITHIN 3 WEEKS



N U B E

ALL VALID FABRICS

SOFT TOUCH TEXTILES - Light



SOFT TOUCH TEXTILES - Warm

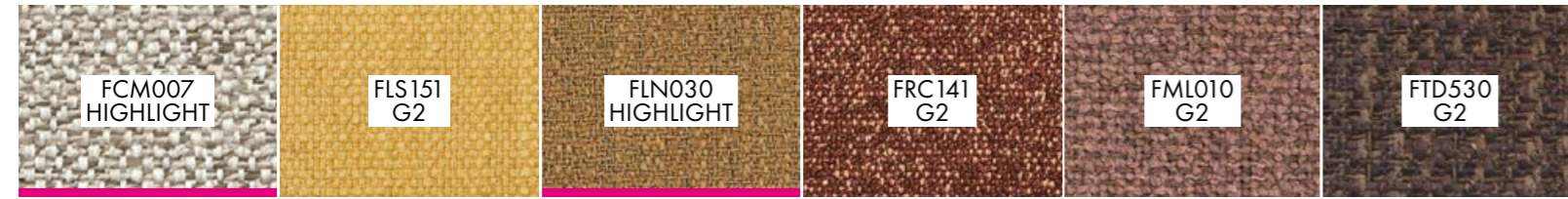

SOFT TOUCH TEXTILES - Cool

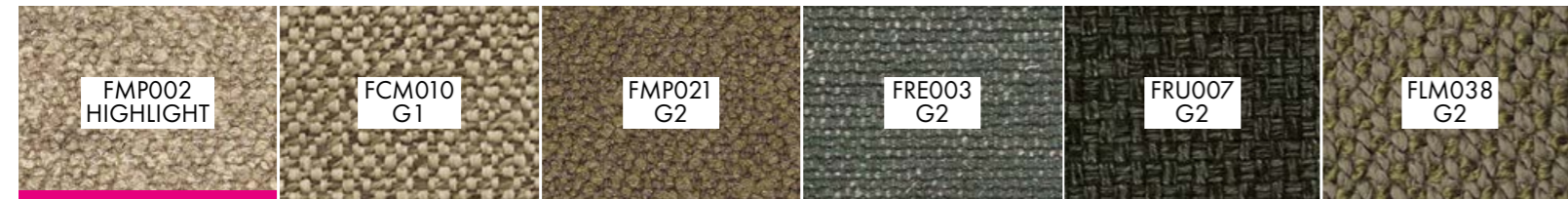

SOFT TOUCH TEXTILES - Grey



TECHNICAL TEXTILES CAMIRA. 100% Natural

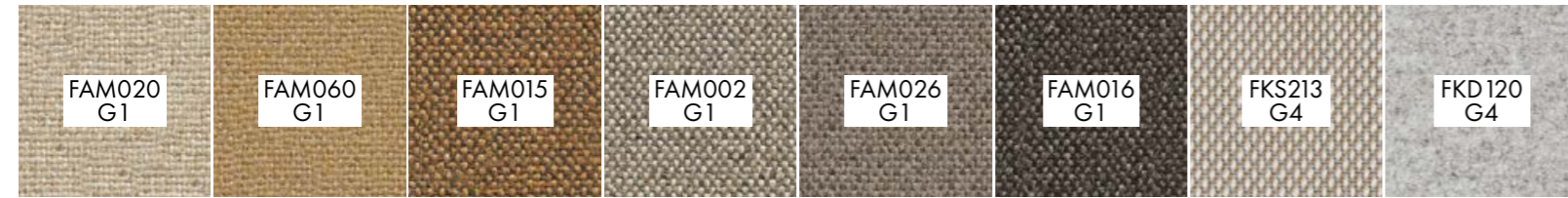

TECH. TEXTILES KVADRAT. Classics

TECHNICAL TEXTILES VESCOM. Recycled



ARTIFICIAL LEATHER



LEATHER NATURAL PROTECTED



LEATHER NATURAL SOFT TOUCH

N U B E

FABRIC GROUP	CODE	CODE	RETAIL
HIGHLIGHT FABRICS	N F-- ---	N2 F-- ---	2392 \$
FABRIC GROUP 1	N F-- ---	N2 F-- ---	2668 \$
FABRIC GROUP 2	N F-- ---	N2 F-- ---	2849 \$
FABRIC GROUP 3	N F-- ---	N2 F-- ---	3046 \$
FABRIC GROUP 4	N F-- ---	N2 F-- ---	3591 \$
COM	N COM	N2 COM	2392 \$



CHROMED LEGS



BLACK LEGS

THE NUBE ARMCHAIRS HIGHLIGHTED IN PINK ARE SHIPPED WITHIN 1 WEEK
THE REST ARE SHIPPED WITHIN 3 WEEKS

MALENA

REMOVABLE COVERS 100%



Nazzano FLN030



Loreto FILO00



Loreto FILO00



Paddington FMP002



MALENA

FAST DELIVERY, SHIPS IN ONE WEEK AND AT A BETTER PRICE





GREY STAINED ASH



NATURAL ASH

MALENA IN HIGHLIGHT FABRICS

	CODE	RETAIL	CODE	RETAIL
 <p>FMB001 HIGHLIGHT</p>	5007 FMB001	2221 \$	5000 FMB001	2221 \$
 <p>FCM007 HIGHLIGHT</p>	5007 FCM007	2221 \$	5000 FCM007	2221 \$
 <p>FMP002 HIGHLIGHT</p>	5007 FMP002	2221 \$	5000 FMP002	2221 \$
 <p>FLN030 HIGHLIGHT</p>	5007 FLN030	2221 \$	5000 FLN030	2221 \$

Malena has removable covers

THESE MALENA ARE SHIPPED WITHIN 1 WEEK
THE REST ARE SHIPPED WITHIN 3 WEEKS

MALENA

ALL FABRICS ARE VALID

SOFT TOUCH TEXTILES - Light



SOFT TOUCH TEXTILES - Warm



SOFT TOUCH TEXTILES - Cool

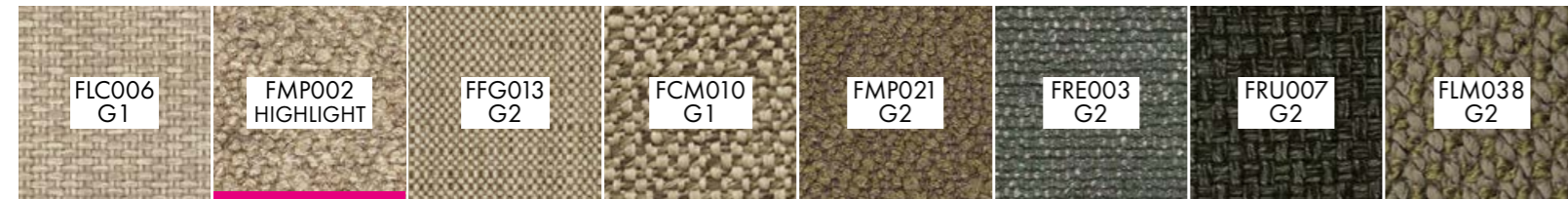

SOFT TOUCH TEXTILES - Grey



TECHNICAL TEXTILES CAMIRA. 100% Natural

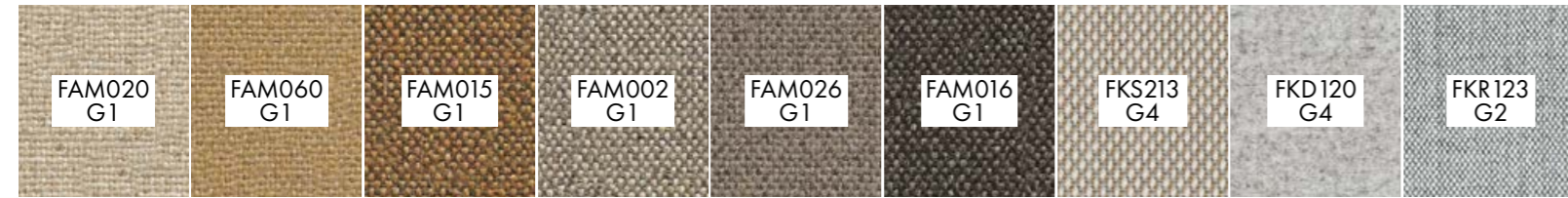

TECHNICAL TEXTILES KVADRAT. Classics

TECHNICAL TEXTILES VESCOM. Recycled



ARTIFICIAL LEATHER



LEATHER NATURAL PROTECTED



MALENA

FABRIC GROUP	CODE	CODE	RETAIL
HIGHLIGHT FABRICS	5007 F-- ---	5000 F-- ---	2221 \$
FABRIC GROUP 1	5007 F-- ---	5000 F-- ---	2615 \$
FABRIC GROUP 2	5007 F-- ---	5000 F-- ---	2682 \$
FABRIC GROUP 3	5007 F-- ---	5000 F-- ---	2851 \$
FABRIC GROUP 4	5007 F-- ---	5000 F-- ---	3035 \$
COM	5007 COM	5000 COM	2221 \$

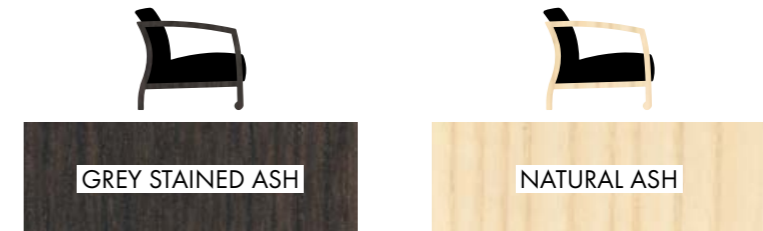

THE MALENA ARMCHAIRS HIGHLIGHTED IN PINK ARE SHIPPED WITHIN 1 WEEK
THE REST ARE SHIPPED WITHIN 3 WEEKS

LIBERA

REMOVABLE COVERS 100%



Gaudi FCG005



Main Line Flax FAM020



Nazzano FLN030



Main Line Flax FCM007



LIBERA

FAST DELIVERY, SHIPS IN ONE WEEK AND AT A BETTER PRICE



BLACK LEGS



OAK TONE



WALNUT LEGS

LIBERA IN HIGHLIGHT FABRICS

Fabric Highlight	Code	Retail	Code	Retail	Code	Retail
FMB001 HIGHLIGHT	LB2 FMB001	2029 \$	LB5 FMB001	2029 \$	LB9 FMB001	2464 \$
FCM007 HIGHLIGHT	LB2 FCM007	2029 \$	LB5 FCM007	2029 \$	LB9 FCM007	2464 \$
FMP002 HIGHLIGHT	LB2 FMP002	2029 \$	LB5 FMP002	2029 \$	LB9 FMP002	2464 \$
FLN030 HIGHLIGHT	LB2 FLN030	2029 \$	LB5 FLN030	2029 \$	LB9 FLN030	2464 \$

Now, all the Libera upholstered in fabric have removable covers.

THESE LIBERA ARE SHIPPED WITHIN 1 WEEK
THE REST ARE SHIPPED WITHIN 3 WEEKS

LIBERA

ALL FABRICS ARE VALID

SOFT TOUCH TEXTILES - Light



SOFT TOUCH TEXTILES - Warm



SOFT TOUCH TEXTILES - Cool

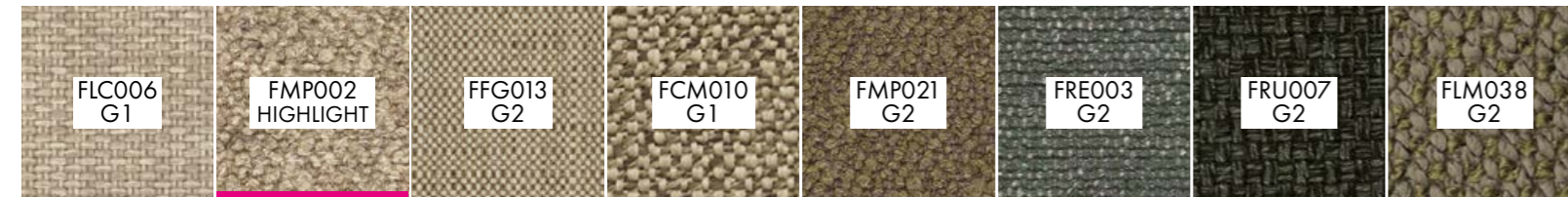

SOFT TOUCH TEXTILES - Grey



TECHNICAL TEXTILES CAMIRA. 100% Natural



TECHNICAL TEXTILES KVADRAT. Classics

TECHNICAL TEXTILES VESCOM. Recycled



ARTIFICIAL LEATHER

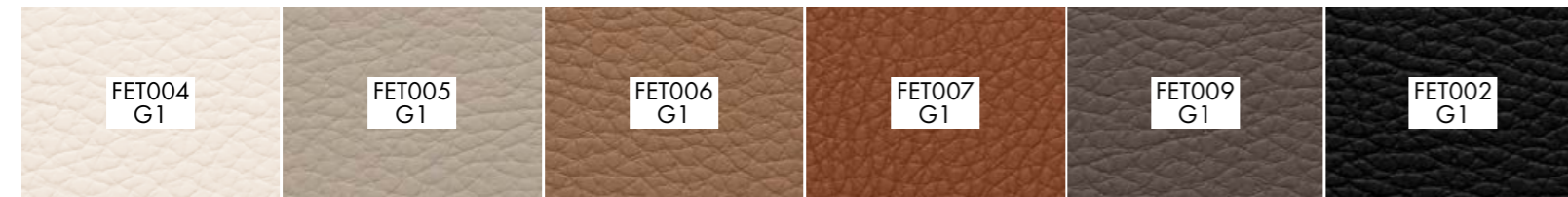

LEATHER NATURAL PROTECTED



LIBERA



FABRIC GROUP	CODE	RETAIL	CODE	RETAIL	CODE	RETAIL
HIGHLIGHT FABRICS	LB2 F-- ---	2029 \$	LB5 F-- ---	2029 \$	LB9 F-- ---	2464 \$
FABRIC GROUP 1	LB2 F-- ---	2108 \$	LB5 F-- ---	2108 \$	LB9 F-- ---	2543 \$
FABRIC GROUP 2	LB2 F-- ---	2259 \$	LB5 F-- ---	2259 \$	LB9 F-- ---	2695 \$
FABRIC GROUP 3	LB2 F-- ---	2385 \$	LB5 F-- ---	2385 \$	LB9 F-- ---	2821 \$
FABRIC GROUP 4	LB2 F-- ---	2862 \$	LB5 F-- ---	2862 \$	LB9 F-- ---	3308 \$
COM	LB2 COM	2029 \$	LB5 COM	2029 \$	LB9 COM	2464 \$

THE LIBERA ARMCHAIRS HIGHLIGHTED IN PINK ARE SHIPPED WITHIN 1 WEEK
THE REST ARE SHIPPED WITHIN 3 WEEKS



COSTURA: HIGHLIGHTS

FAST DELIVERY, SHIPS IN ONE WEEK AND AT A BETTER PRICE

REMOVABLE COVERS 100%

				
COSTURA IN HIGHLIGHT FABRICS	ARMCHAIR 86 cm	SOFA 156 cm	SOFA 226 cm	CHAISE ALONE 90 x 160 cm
PRICES	RETAIL 3080 \$	RETAIL 4545 \$	RETAIL 6134 \$	RETAIL 3629 \$

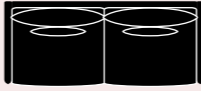
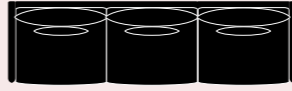
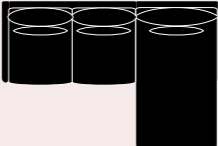
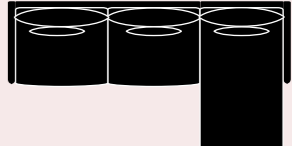
			
SOFA 216 cm	SOFA 316 cm	SOFA + CHAISE 246 cm	SOFA + CHAISE 306 cm
RETAIL 5899 \$	RETAIL 8107 \$	RETAIL 8174 \$	RETAIL 9527 \$



CODE	CODE	CODE	CODE
HBID FCG005	HRID FCG005	HLID FCG005	HCX FCG005

CODE	CODE	CODE	CODE
HSID FCG005	HSID HM FCG005	HRID HC FCG005	HSID HC FCG005



HBID FCM007	HRID FCM007	HLID FCM007	HCX FCM007
-------------	-------------	-------------	------------

HSID FCM007	HSID HM FCM007	HRID HC FCM007	HSID HC FCM007
-------------	----------------	----------------	----------------



HBID FCM010	HRID FCM010	HLID FCM010	HCX FCM010
-------------	-------------	-------------	------------

HSID FCM010	HSID HM FCM010	HRID HC FCM010	HSID HC FCM010
-------------	----------------	----------------	----------------

HIGHLIGHT FABRICS BY CREVIN

- Machine washable
- Easy to clean
- Highly durable
- Made in Spain
- Free of PFAs
- Oeko Tex
- With a 5 year guarantee

THESE COSTURA CONFIGURATIONS ARE SHIPPED WITHIN A WEEK
THE REST ARE SHIPPED WITHIN 3 WEEKS

COSTURA

ALL FABRICS ARE VALID

SOFT TOUCH TEXTILES - Light



SOFT TOUCH TEXTILES - Warm

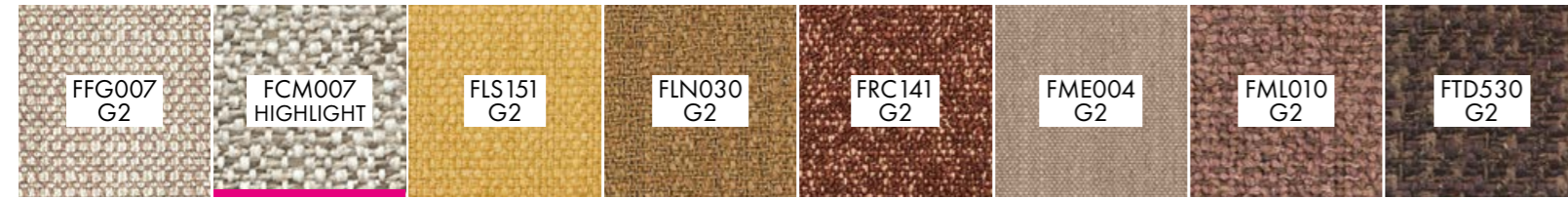

SOFT TOUCH TEXTILES - Cool

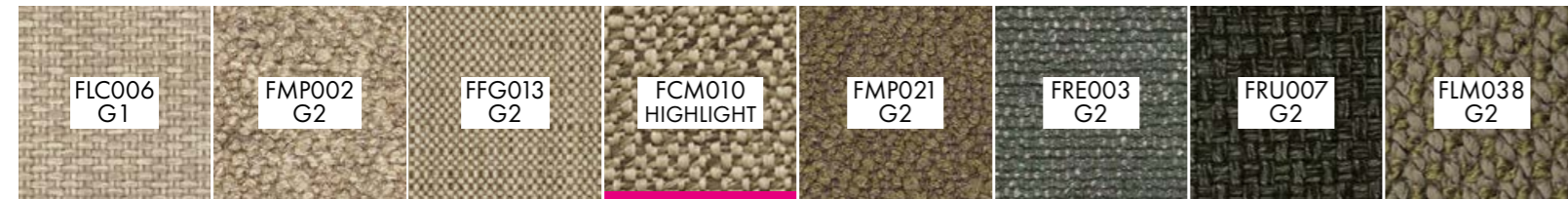

SOFT TOUCH TEXTILES - Grey



TECHNICAL TEXTILES CAMIRA. 100% Natural

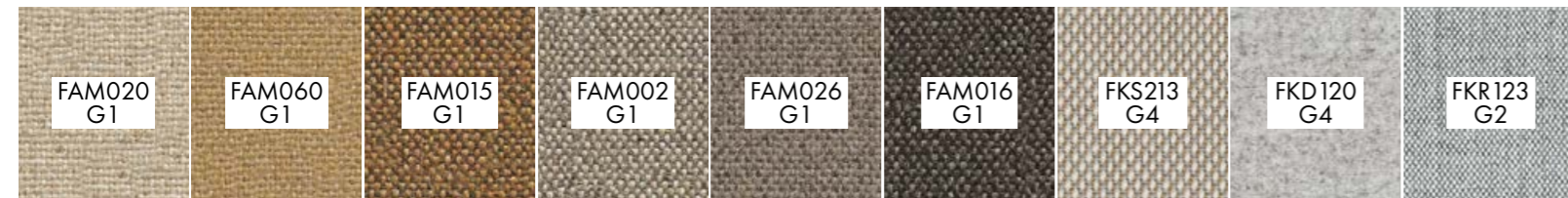

TECHNICAL TEXTILES KVADRAT. Classics

TECHNICAL TEXTILES VESCOM. Recycled



ARTIFICIAL LEATHER

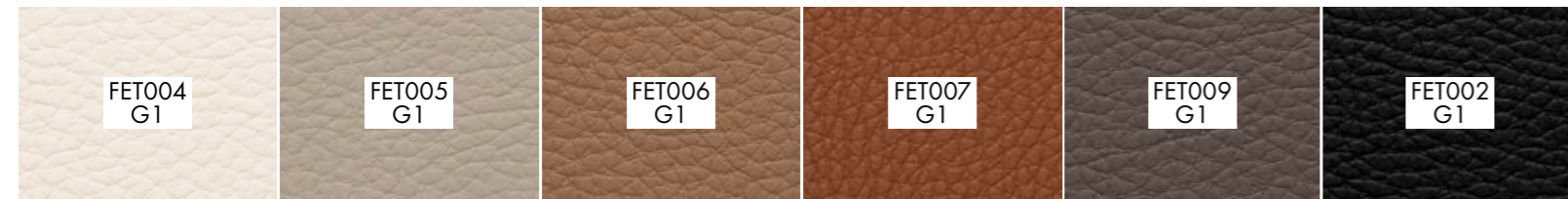

LEATHER NATURAL PROTECTED



LEATHER NATURAL SOFT TOUCH

CREATE YOUR OWN COSTURA

FABRIC GROUP	ARMS		8 BODIES						
	LEFT 8 cm Code: HI	RIGHT 8 cm Code: HD	ARMCHAIR 70 cm Code: HB	MINISOFA 100 cm Code: HM	SOFA 140 cm Code: HR	SOFA 200 cm Code: HS	SOFA 210 cm Code: HL	CHAISELONGUE 90 x 160 cm Code: HC	CORNER 90 x 90 cm Code: HA
HIGHLIGHT	740 \$	740 \$	1600 \$	2209 \$	3065 \$	4419 \$	4655 \$	3629 \$	3312 \$
GROUP 1	835 \$	835 \$	1951 \$	2437 \$	3386 \$	4973 \$	5144 \$	4055 \$	3728 \$
GROUP 2	907 \$	907 \$	2155 \$	2693 \$	3649 \$	5366 \$	5587 \$	4315 \$	4016 \$
GROUP 3	1076 \$	1076 \$	2592 \$	3242 \$	4525 \$	6642 \$	6858 \$	4988 \$	4981 \$
GROUP 4	1643 \$	1643 \$	3465 \$	4331 \$	6748 \$	9979 \$	10116 \$	6367 \$	6748 \$
COM FABRIC	740 \$	740 \$	1600 \$	2209 \$	3065 \$	4419 \$	4655 \$	3629 \$	3312 \$
Fabric needed *	1,1 m	1,1 m	5,5 m	5,5 m	10 m	10 m	15 m	6,7 m	6 m
Leather needed	½ hide	½ hide	1 hide	2 hides	2½ hides	3 hides	3½ hides	2 hides	2 hides

* For directional fabrics add +30% to the fabric needs.

COSTURA

COMPONENTS

REMOVABLE COVERS 100%

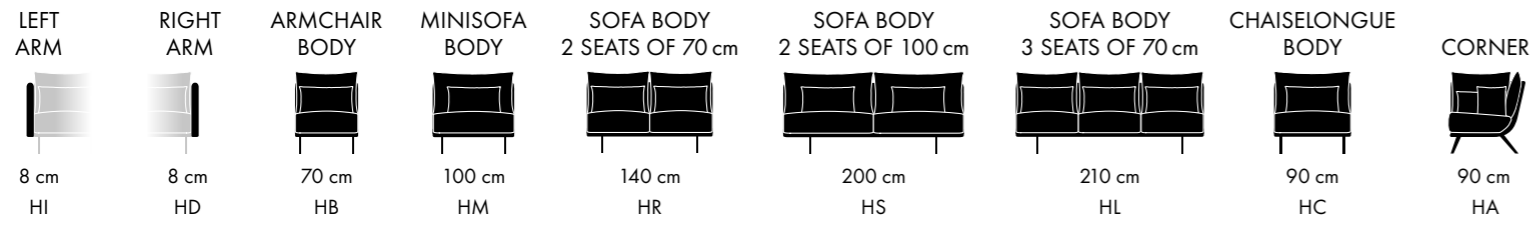

HEIGHTS:



PILLOWS

- One small pillow of 30 x 60 cm cushion is included with every seat. Always in the textile of the sofa.
- The corner includes one 30 x 60 cm, and one 40 x 40 cm pillow.

SIMPLE CONFIGURATIONS

70 CM SEATS

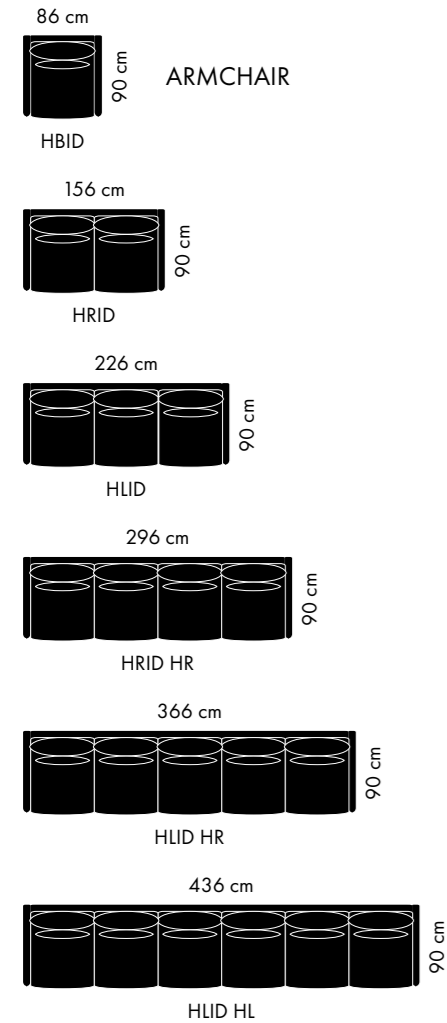

OTTOMAN 70 x 90 CM



100 CM SEATS

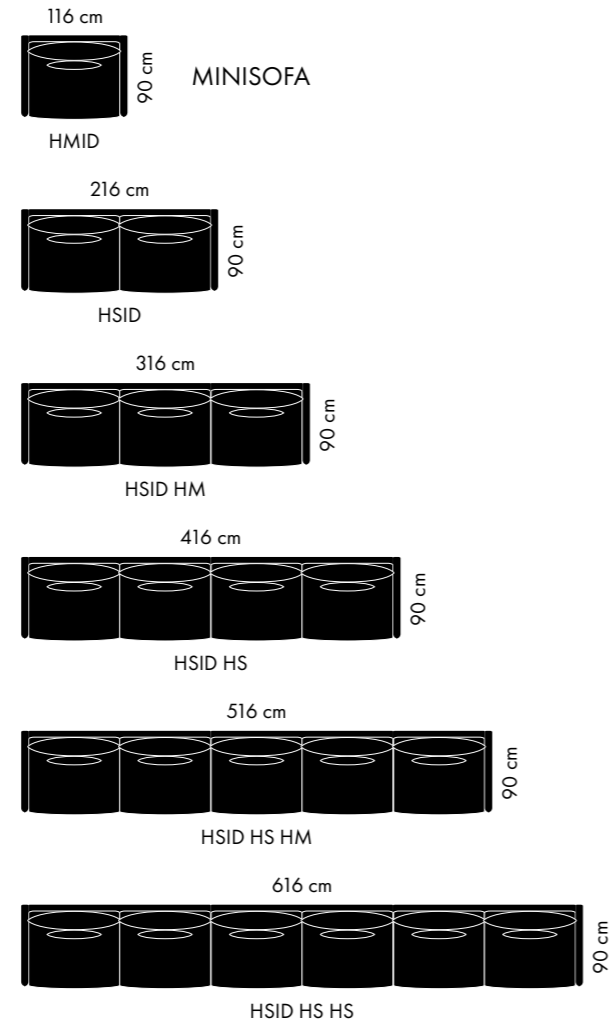

CHAISELONGUE: 90 CM SEAT

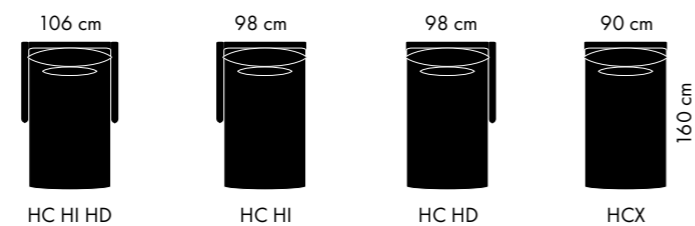

CHOOSE AND REARRANGE ANYTIME



COSTURA

ARMCHAIR, MINISOFA & OTTOMAN

ARMCHAIR: 86 CM

Code: HBID

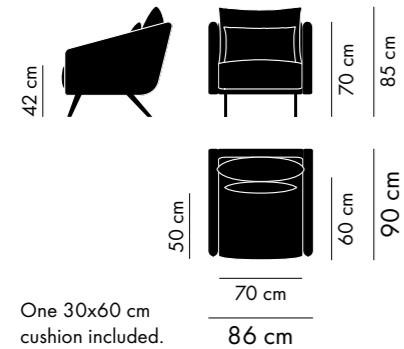

One 30x60 cm cushion included.

FABRIC	CODE	RETAIL
HIGHLIGHT	HBID F-- ---	3080 \$
GROUP 1	HBID F-- ---	3622 \$
GROUP 2	HBID F-- ---	3969 \$
GROUP 3	HBID F-- ---	4745 \$
GROUP 4	HBID F-- ---	6752 \$
COM fabric	HBID COM	3080 \$

Fabric needed: 7,5 m
Leather needed: 2 hides

MINISOFA 1 SEAT: 116 CM

Code: HMDID

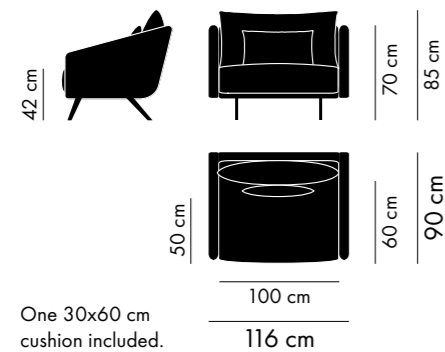

One 30x60 cm cushion included.

FABRIC	CODE	RETAIL
HIGHLIGHT	HMDID F-- ---	3688 \$
GROUP 1	HMDID F-- ---	4108 \$
GROUP 2	HMDID F-- ---	4507 \$
GROUP 3	HMDID F-- ---	5395 \$
GROUP 4	HMDID F-- ---	7618 \$
COM fabric	HMDID COM	3688 \$

Fabric needed: 8 m
Leather needed: 3 hides

OTTOMAN: 70 X 90 CM

Code: HO

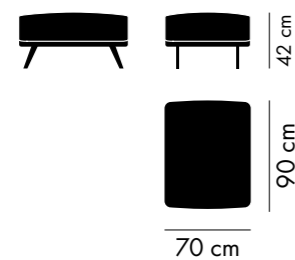

The width of the ottoman matches the width of the chaise on one side, and the width of the armchair on the other.

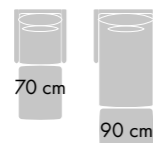

FABRIC	CODE	RETAIL
HIGHLIGHT	HO F-- ---	1429 \$
GROUP 1	HO F-- ---	1579 \$
GROUP 2	HO F-- ---	1692 \$
GROUP 3	HO F-- ---	1894 \$
GROUP 4	HO F-- ---	2362 \$
COM fabric	HO COM	1429 \$

Fabric needed: 2,3 m
Leather needed: 1 hide

COSTURA

CHAISELONGUE

CHAISELONGUE WITHOUT ARMS: 90 CM

- STAND ALONE - Code: HCX (Cannot be connected to a sofa)

- TO BE CONNECTED TO A SOFA - Code: HC

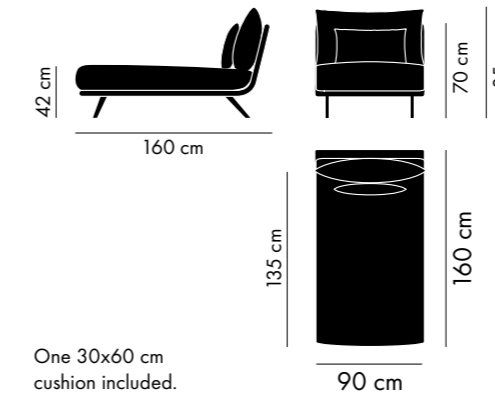

One 30x60 cm cushion included.

CHAISELONGUE WITH ONE ARM: 98 CM

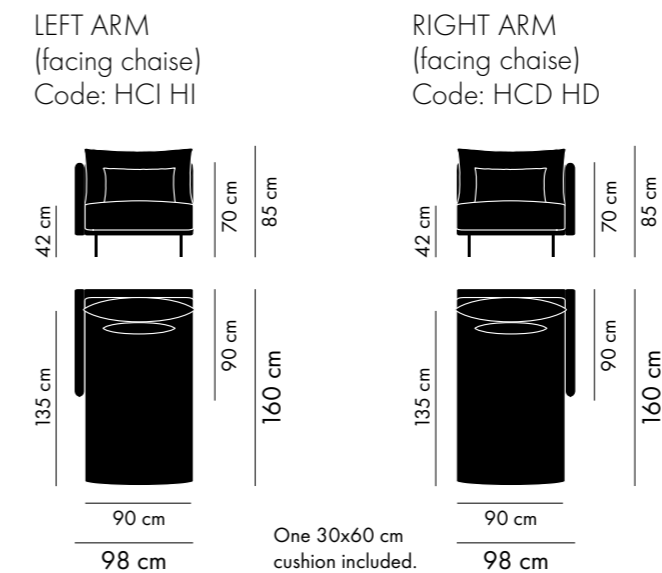

One 30x60 cm cushion included.

CHAISELONGUE WITH TWO ARMS: 106 CM

Code: HC HI HD

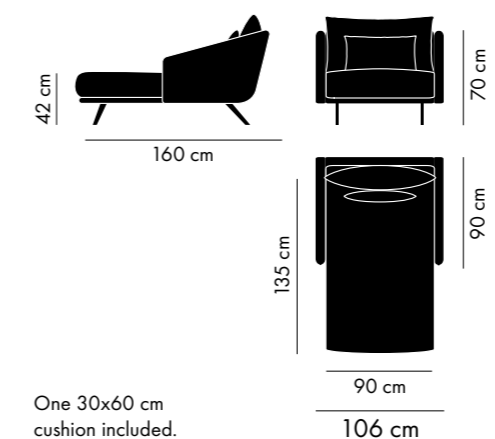

One 30x60 cm cushion included.

FABRIC	INDIVIDUAL CODE	CONNECTED TO A SOFA CODE	RETAIL
HIGHLIGHT	HCX F-- ---	HC F-- ---	3629 \$
GROUP 1	HCX F-- ---	HC F-- ---	4055 \$
GROUP 2	HCX F-- ---	HC F-- ---	4315 \$
GROUP 3	HCX F-- ---	HC F-- ---	4988 \$
GROUP 4	HCX F-- ---	HC F-- ---	6367 \$
COM fabric	HCX COM	HC COM	3629 \$

Fabric needed: 7 m
Leather needed: 2 hides

FABRIC	LEFT ARM CODE	RIGHT ARM CODE	RETAIL
HIGHLIGHT	HCI HI F-- ---	HCD HD F-- ---	4369 \$
GROUP 1	HCI HI F-- ---	HCD HD F-- ---	4891 \$
GROUP 2	HCI HI F-- ---	HCD HD F-- ---	5222 \$
GROUP 3	HCI HI F-- ---	HCD HD F-- ---	6064 \$
GROUP 4	HCI HI F-- ---	HCD HD F-- ---	8010 \$
COM fabric	HCI HI COM	HCD HD COM	4369 \$

Fabric needed: 8 m
Leather needed: 2½ hides

FABRIC	CODE	RETAIL
HIGHLIGHT	HC HI HD F-- ---	5108 \$
GROUP 1	HC HI HD F-- ---	5726 \$
GROUP 2	HC HI HD F-- ---	6129 \$
GROUP 3	HC HI HD F-- ---	7141 \$
GROUP 4	HC HI HD F-- ---	9653 \$
COM fabric	HC HI HD COM	5108 \$

Fabric needed: 9 m
Leather needed: 3 hides

COSTURA

SOFAS WITH 70 CM SEATS

SOFA WITH 2 SEATS OF 70 CM: 156 CM

Code: HRID

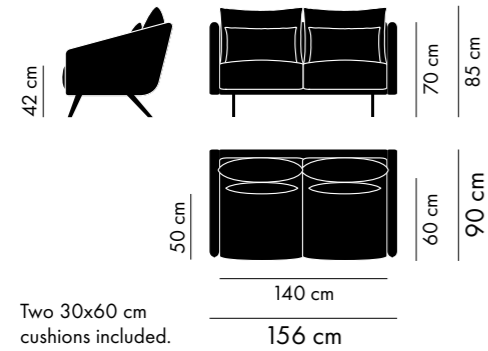

FABRIC	CODE	RETAIL
HIGHLIGHT	HRID F-- ---	4545 \$
GROUP 1	HRID F-- ---	5056 \$
GROUP 2	HRID F-- ---	5463 \$
GROUP 3	HRID F-- ---	6678 \$
GROUP 4	HRID F-- ---	10035 \$
COM fabric	HRID COM	4545 \$

Fabric needed: 12,5 m
Leather needed: 3½ hides

SOFA WITH 3 SEATS OF 70 CM: 226 CM

Code: HLID

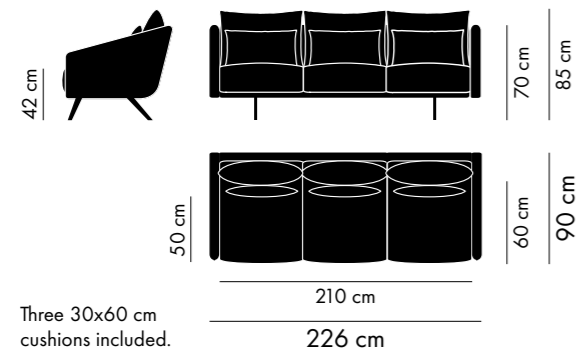

FABRIC	CODE	RETAIL
HIGHLIGHT	HLID F-- ---	6134 \$
GROUP 1	HLID F-- ---	6815 \$
GROUP 2	HLID F-- ---	7402 \$
GROUP 3	HLID F-- ---	9011 \$
GROUP 4	HLID F-- ---	13403 \$
COM fabric	HLID COM	6134 \$

Fabric needed: 17,5 m
Leather needed: 5 hides

SOFA WITH 4 SEATS OF 70 CM: 296 CM

Code: HRID HR

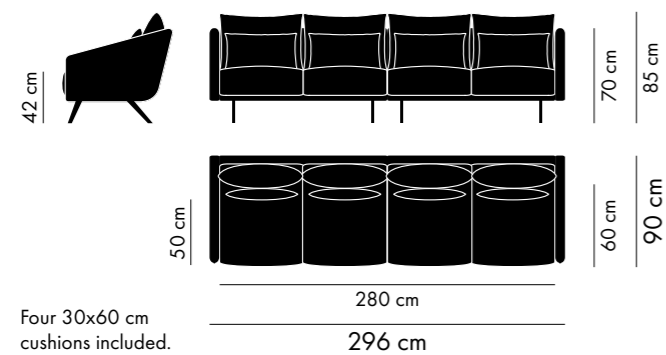

FABRIC	CODE	RETAIL
HIGHLIGHT	HRID HR F-- ---	7610 \$
GROUP 1	HRID HR F-- ---	8442 \$
GROUP 2	HRID HR F-- ---	9112 \$
GROUP 3	HRID HR F-- ---	11203 \$
GROUP 4	HRID HR F-- ---	16783 \$
COM fabric	HRID HR COM	7610 \$

Fabric needed: 22,5 m
Leather needed: 6½ hides

COSTURA

SOFAS WITH 100 CM SEATS

SOFA WITH 2 SEATS OF 100 CM: 216 CM

Code: HSID

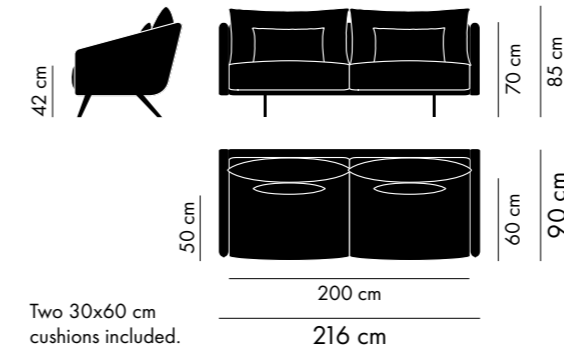

FABRIC	CODE	RETAIL
HIGHLIGHT	HSID F-- ---	5899 \$
GROUP 1	HSID F-- ---	6644 \$
GROUP 2	HSID F-- ---	7180 \$
GROUP 3	HSID F-- ---	8795 \$
GROUP 4	HSID F-- ---	13266 \$
COM fabric	HSID COM	5899 \$

Fabric needed: 12,5 m
Leather needed: 4 hides

SOFA WITH 3 SEATS OF 100 CM: 316 CM

Code: HSID HM

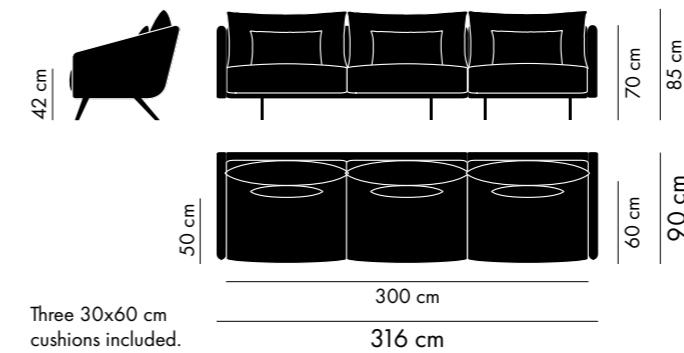

FABRIC	CODE	RETAIL
HIGHLIGHT	HSID HM F-- ---	8107 \$
GROUP 1	HSID HM F-- ---	9081 \$
GROUP 2	HSID HM F-- ---	9873 \$
GROUP 3	HSID HM F-- ---	12037 \$
GROUP 4	HSID HM F-- ---	17597 \$
COM fabric	HSID HM COM	8107 \$

Fabric needed: 17,5 m
Leather needed: 6 hides

SOFA WITH 4 SEATS OF 100 CM: 416 CM

Code: HSID HS

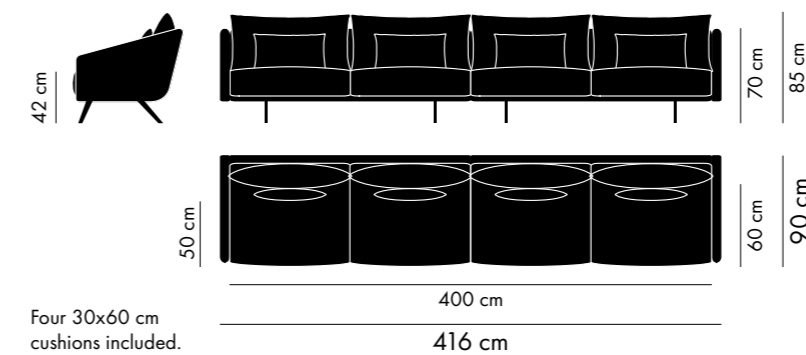

FABRIC	CODE	RETAIL
HIGHLIGHT	HSID HS F-- ---	10318 \$
GROUP 1	HSID HS F-- ---	11617 \$
GROUP 2	HSID HS F-- ---	12546 \$
GROUP 3	HSID HS F-- ---	15437 \$
GROUP 4	HSID HS F-- ---	23245 \$
COM fabric	HSID HS COM	10318 \$

Fabric needed: 22,5 m
Leather needed: 7 hides

C O S T U R A

SOFAS WITH 70 CM SEATS + CHAISELONGUE

ARMCHAIR WITH CHAISELONGUE: 176 CM
Code: HBID HC

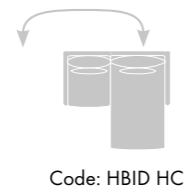
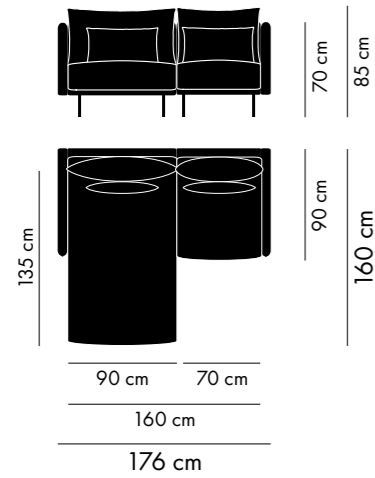

Code: HBID HC

Two 30x60 cm cushions included.

FABRIC	CODE	RETAIL
HIGHLIGHT	HBID HC F-- ---	6709 \$
GROUP 1	HBID HC F-- ---	7677 \$
GROUP 2	HBID HC F-- ---	8284 \$
GROUP 3	HBID HC F-- ---	9733 \$
GROUP 4	HBID HC F-- ---	13118 \$
COM fabric	HBID HC COM	6709 \$

Fabric needed: 14,5 m
Leather needed: 4 hides

The chaiselongue can be attached to the right or left side, and reconfigured whenever you wish.

SOFA WITH 2 SEATS OF 70 CM AND CHAISELONGUE: 246 CM
Code: HRID HC

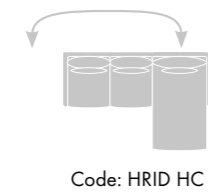
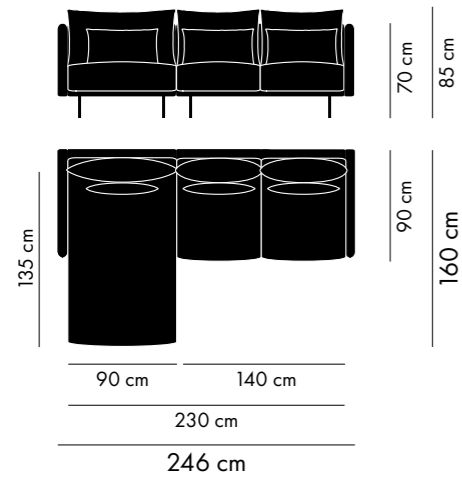

Code: HRID HC

Three 30x60 cm cushions included.

FABRIC	CODE	RETAIL
HIGHLIGHT	HRID HC F-- ---	8174 \$
GROUP 1	HRID HC F-- ---	9112 \$
GROUP 2	HRID HC F-- ---	9778 \$
GROUP 3	HRID HC F-- ---	11666 \$
GROUP 4	HRID HC F-- ---	16402 \$
COM fabric	HRID HC COM	8174 \$

Fabric needed: 19 m
Leather needed: 5½ hides

SOFA WITH 3 SEATS OF 70 CM AND CHAISELONGUE: 316 CM
Code: HLID HC

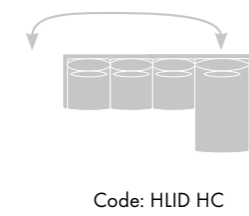
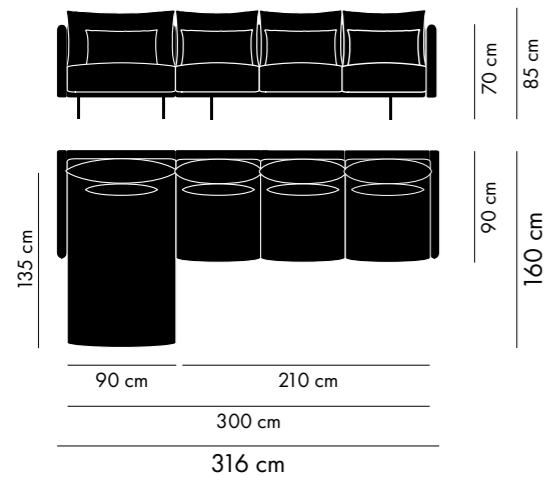

Code: HLID HC

Four 30x60 cm cushions included.

FABRIC	CODE	RETAIL
HIGHLIGHT	HLID HC F-- ---	9763 \$
GROUP 1	HLID HC F-- ---	10870 \$
GROUP 2	HLID HC F-- ---	11716 \$
GROUP 3	HLID HC F-- ---	13999 \$
GROUP 4	HLID HC F-- ---	19769 \$
COM fabric	HLID HC COM	9763 \$

Fabric needed: 24,5 m
Leather needed: 6½ hides

C O S T U R A

SOFAS WITH 100 CM SEATS + CHAISELONGUE

MINISOFA WITH CHAISELONGUE: 206 CM
Code: HMID HC

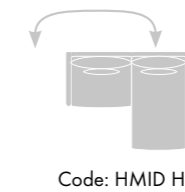
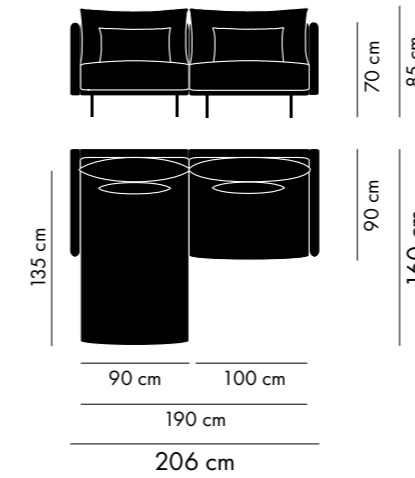

Code: HMID HC

Two 30x60 cm cushions included.

FABRIC	CODE	RETAIL
HIGHLIGHT	HMID HC F-- ---	7317 \$
GROUP 1	HMID HC F-- ---	8163 \$
GROUP 2	HMID HC F-- ---	8822 \$
GROUP 3	HMID HC F-- ---	10382 \$
GROUP 4	HMID HC F-- ---	13984 \$
COM fabric	HMID HC COM	7317 \$

Fabric needed: 14,5 m
Leather needed: 5 hides

The chaiselongue can be attached to the right or left side, and reconfigured whenever you wish.

SOFA WITH 2 SEATS OF 100 CM AND CHAISELONGUE: 306 CM
Code: HSID HC

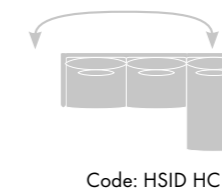
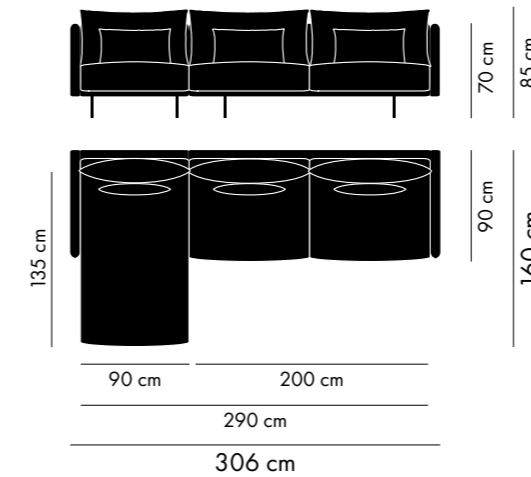

Code: HSID HC

Three 30x60 cm cushions included.

FABRIC	CODE	RETAIL
HIGHLIGHT	HSID HC F-- ---	9527 \$
GROUP 1	HSID HC F-- ---	10699 \$
GROUP 2	HSID HC F-- ---	11495 \$
GROUP 3	HSID HC F-- ---	13783 \$
GROUP 4	HSID HC F-- ---	19633 \$
COM fabric	HSID HC COM	9527 \$

Fabric needed: 19 m
Leather needed: 6 hides

SOFA WITH 3 SEATS OF 100 CM AND CHAISELONGUE: 406 CM
Code: HSID HM HC

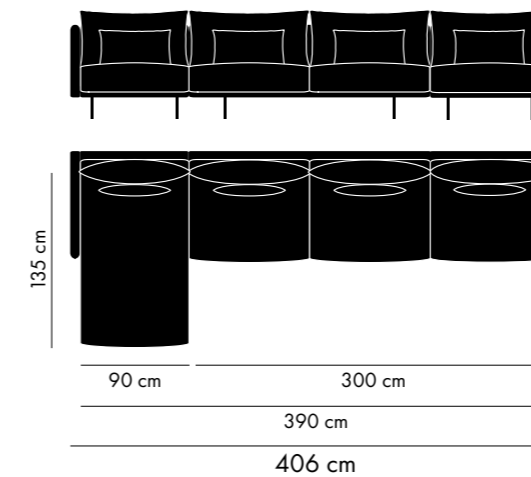

Code: HSID HM HC

Four 30x60 cm cushions included.

FABRIC	CODE	RETAIL
HIGHLIGHT	HSID HM HC F-- ---	11736 \$
GROUP 1	HSID HM HC F-- ---	13136 \$
GROUP 2	HSID HM HC F-- ---	14188 \$
GROUP 3	HSID HM HC F-- ---	17024 \$
GROUP 4	HSID HM HC F-- ---	23963 \$
COM fabric	HSID HM HC COM	11736 \$

Fabric needed: 24,5 m
Leather needed: 8 hides

C O S T U R A

CORNER SOFAS WITH 70 CM SEATS

SOFA WITH 2+1 SEATS OF 70 CM + CORNER: 238 X 168 CM

Code: HRID HB HA

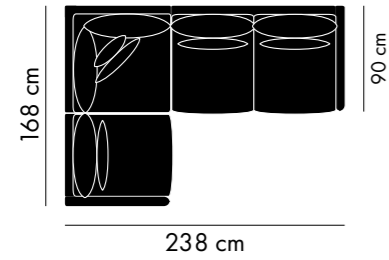

Four 30x60 cm and one 40x40 cm cushions included.

FABRIC	CODE	RETAIL
HIGHLIGHT	HRID HB HA F-- ---	9457 \$
GROUP 1	HRID HB HA F-- ---	10735 \$
GROUP 2	HRID HB HA F-- ---	11633 \$
GROUP 3	HRID HB HA F-- ---	14251 \$
GROUP 4	HRID HB HA F-- ---	20248 \$
COM fabric	HRID HB HA COM	9457 \$

Fabric needed: 24 m
Leather needed: 7 hides

SOFA 2+2 SEATS OF 70 CM + CORNER: 238 X 238 CM

Code: HRID HR HA

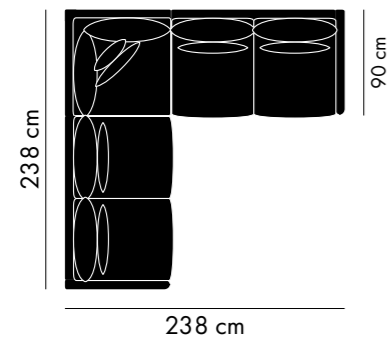

Five 30x60 cm and one 40x40 cm cushions included.

FABRIC	CODE	RETAIL
HIGHLIGHT	HRID HR HA F-- ---	10922 \$
GROUP 1	HRID HR HA F-- ---	12170 \$
GROUP 2	HRID HR HA F-- ---	13127 \$
GROUP 3	HRID HR HA F-- ---	16184 \$
GROUP 4	HRID HR HA F-- ---	23531 \$
COM fabric	HRID HR HA COM	10922 \$

Fabric needed: 28 m
Leather needed: 8 hides

SOFA WITH 3+1 SEATS OF 70 CM + CORNER: 308 X 168 CM

Code: HLID HB HA

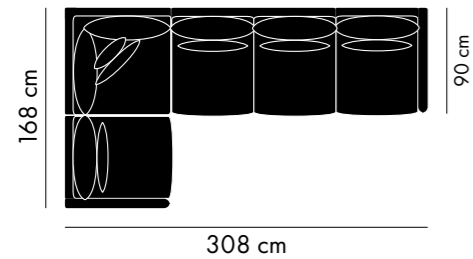

Five 30x60 cm and one 40x40 cm cushions included.

FABRIC	CODE	RETAIL
HIGHLIGHT	HLID HB HA F-- ---	11047 \$
GROUP 1	HLID HB HA F-- ---	12494 \$
GROUP 2	HLID HB HA F-- ---	13572 \$
GROUP 3	HLID HB HA F-- ---	16583 \$
GROUP 4	HLID HB HA F-- ---	23616 \$
COM fabric	HLID HB HA COM	11047 \$

Fabric needed: 28 m
Leather needed: 8 hides

C O S T U R A

CORNER SOFAS WITH 100 CM SEATS

SOFA WITH 2+1 SEATS OF 100 CM + CORNER: 298 X 198 CM

Code: HSID HM HA

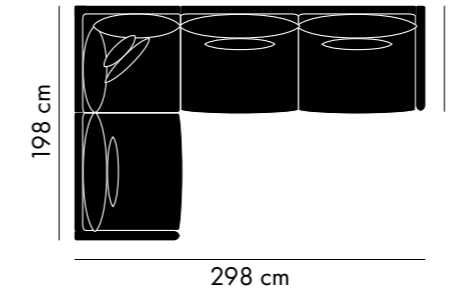

Four 30x60 cm and one 40x40 cm cushions included.

FABRIC	CODE	RETAIL
HIGHLIGHT	HSID HM HA F-- ---	11419 \$
GROUP 1	HSID HM HA F-- ---	12809 \$
GROUP 2	HSID HM HA F-- ---	13889 \$
GROUP 3	HSID HM HA F-- ---	17017 \$
GROUP 4	HSID HM HA F-- ---	24345 \$
COM fabric	HSID HM HA COM	11419 \$

Fabric needed: 24 m
Leather needed: 8 hides

SOFA WITH 2+2 SEATS OF 100 CM + CORNER: 298 X 298 CM

Code: HSID HS HA

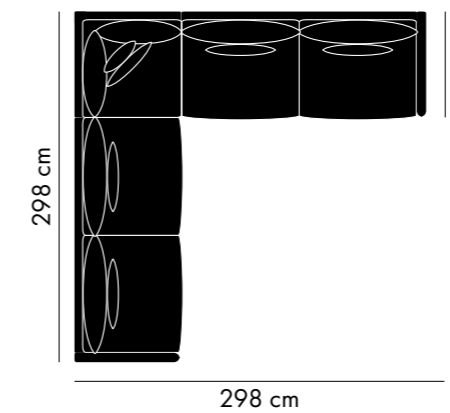

Five 30x60 cm and one 40x40 cm cushions included.

FABRIC	CODE	RETAIL
HIGHLIGHT	HSID HS HA F-- ---	13630 \$
GROUP 1	HSID HS HA F-- ---	15345 \$
GROUP 2	HSID HS HA F-- ---	16562 \$
GROUP 3	HSID HS HA F-- ---	20417 \$
GROUP 4	HSID HS HA F-- ---	29993 \$
COM fabric	HSID HS HA COM	13630 \$

Fabric needed: 28,5 m
Leather needed: 9 hides

SOFA WITH 3+1 SEATS OF 100 CM + CORNER: 398 X 198 CM

Code: HSID HM HM HA

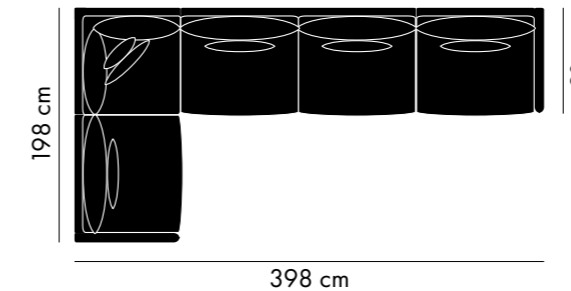

Five 30x60 cm and one 40x40 cm cushions included.

FABRIC	CODE	RETAIL
HIGHLIGHT	HSID HM HM HA F-- ---	13628 \$
GROUP 1	HSID HM HM HA F-- ---	15246 \$
GROUP 2	HSID HM HM HA F-- ---	16582 \$
GROUP 3	HSID HM HM HA F-- ---	20259 \$
GROUP 4	HSID HM HM HA F-- ---	28676 \$
COM fabric	HSID HM HM HA COM	13628 \$

Fabric needed: 28,5 m
Leather needed: 9 hides

COSTURA

OTHER CORNER SOFAS

SOFA WITH 3+2 SEATS OF 100 CM + CORNER: 398 X 298 CM

Code: HSID HS HM HA

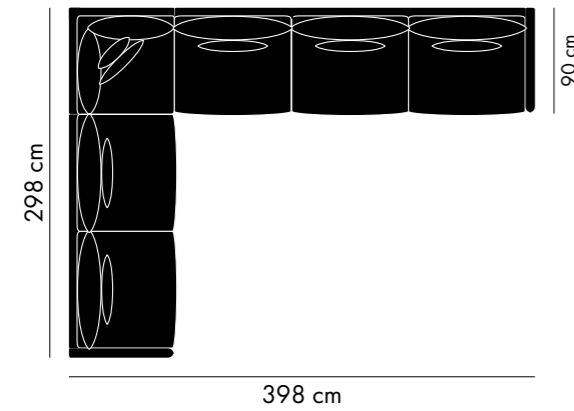

Six 30x60 cm and one 40x40 cm cushions included.

FABRIC	CODE	RETAIL
HIGHLIGHT	HSID HS HM HA F-- ---	15838 \$
GROUP 1	HSID HS HM HA F-- ---	17782 \$
GROUP 2	HSID HS HM HA F-- ---	19255 \$
GROUP 3	HSID HS HM HA F-- ---	23659 \$
GROUP 4	HSID HS HM HA F-- ---	34324 \$
COM fabric	HSID HS HM HA COM	15838 \$

Fabric needed: 34 m
Leather needed: 11 hides

SOFA WITH 3+2 SEATS OF 70 CM + CORNER: 308 X 238 CM

Code: HLID HR HA

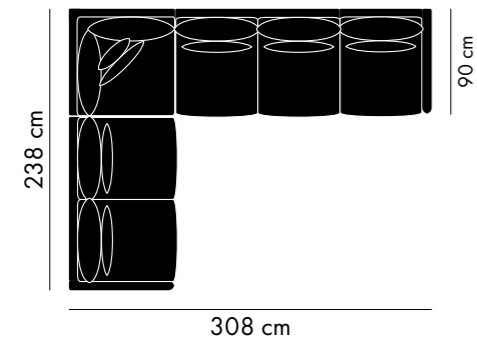

Six 30x60 cm and one 40x40 cm cushions included.

FABRIC	CODE	RETAIL
HIGHLIGHT	HLID HR HA F-- ---	12512 \$
GROUP 1	HLID HR HA F-- ---	13928 \$
GROUP 2	HLID HR HA F-- ---	15066 \$
GROUP 3	HLID HR HA F-- ---	18517 \$
GROUP 4	HLID HR HA F-- ---	26899 \$
COM fabric	HLID HR HA COM	12512 \$

Fabric needed: 33 m
Leather needed: 9 hides

SOFA WITH 2 SEATS OF 100 CM + 2 SEATS OF 70 CM + CORNER: 298 X 238 CM

Code: HSID HR HA

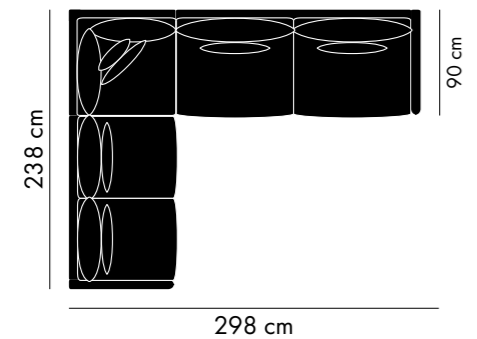

Five 30x60 cm and one 40x40 cm cushions included.

FABRIC	CODE	RETAIL
HIGHLIGHT	HSID HR HA F-- ---	12276 \$
GROUP 1	HSID HR HA F-- ---	13757 \$
GROUP 2	HSID HR HA F-- ---	14845 \$
GROUP 3	HSID HR HA F-- ---	18301 \$
GROUP 4	HSID HR HA F-- ---	26762 \$
COM fabric	HSID HR HA COM	12276 \$

Fabric needed: 28 m
Leather needed: 8½ hides

COSTURA

OTHER CONFIGURATION EXAMPLES

SOFA WITH 2 CHAISERLONGUES: 396 CM

Code: HSID HC HC

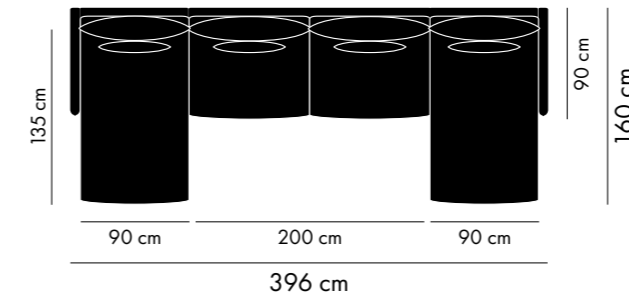

Four 30x60 cm cushions included.

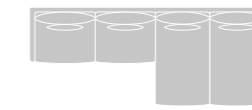

Code: HSID HC HC

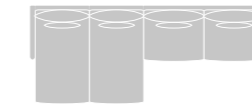

Code: HSID HC HC

FABRIC	CODE	RETAIL
HIGHLIGHT	HSID HC HC F-- ---	13156 \$
GROUP 1	HSID HC HC F-- ---	14755 \$
GROUP 2	HSID HC HC F-- ---	15809 \$
GROUP 3	HSID HC HC F-- ---	18770 \$
GROUP 4	HSID HC HC F-- ---	25999 \$
COM fabric	HSID HC HC COM	13156 \$

Fabric needed: 26 m
Leather needed: 8 hides

The chaiselongue can be attached to the right or left side, and reconfigured whenever you wish.

SOFA WITH 2+1+1 SEATS OF 100 CM + 2 CORNERS: 380 X 198 CM

Code: HSID HM HM HA HA

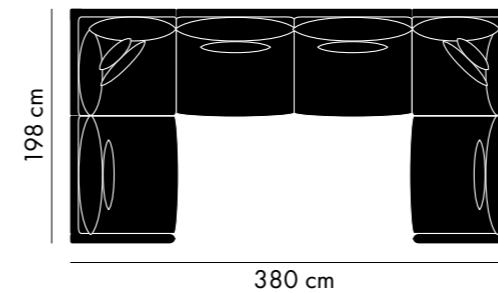

Six 30x60 cm and two 40x40 cm cushions included.

FABRIC	CODE	RETAIL
HIGHLIGHT	HSID HM HM HA HA F-- ---	16940 \$
GROUP 1	HSID HM HM HA HA F-- ---	18974 \$
GROUP 2	HSID HM HM HA HA F-- ---	20597 \$
GROUP 3	HSID HM HM HA HA F-- ---	25240 \$
GROUP 4	HSID HM HM HA HA F-- ---	35424 \$
COM fabric	HSID HM HM HA HA COM	16940 \$

Fabric needed: 35,5 m
Leather needed: 12 hides

SOFA WITH 2+1 SEATS OF 100 CM + CORNER + CHAISERLONGUE: 388 X 198 CM

Code: HSID HM HA HC

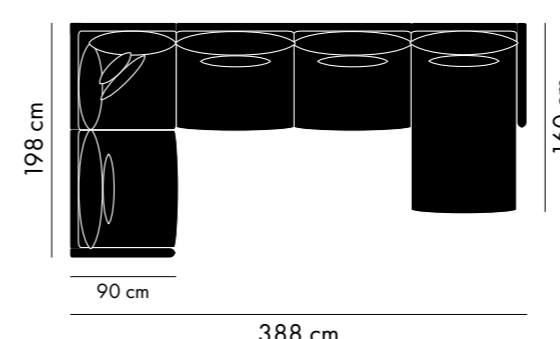

Five 30x60 cm and one 40x40 cm cushions included.



Code: HSID HM HA HC

FABRIC	CODE	RETAIL
HIGHLIGHT	HSID HM HA HC F-- ---	15048 \$
GROUP 1	HSID HM HA HC F-- ---	16864 \$
GROUP 2	HSID HM HA HC F-- ---	18203 \$
GROUP 3	HSID HM HA HC F-- ---	22005 \$
GROUP 4	HSID HM HA HC F-- ---	30712 \$
COM fabric	HSID HM HA HC COM	15048 \$

Fabric needed: 31 m
Leather needed: 10 hides

C O S T U R A

CUSHIONS

PILLOW TEXTILES	PRODUCED
STUA TEXTILES	YES
NON STUA KVADRAT: ONLY PILLOWS	NO
NON STUA KVADRAT: SOFA WITH PILLOWS	YES
OTHER MANUFACTURER'S TEXTILES	NO
COM: SOFA WITH PILLOWS	YES

RECTANGULAR BACK CUSHION

30 x 60 cm

Code: C36

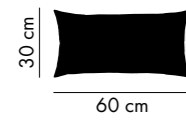

30 x 60 cm cushion weight: 1 Kg.

One 30x60 cushion is included with every seat of the Costura Armchair, Sofa, Corner or Chaiselongue.

PACKING: 30 X 60 CUSHION

1 cushion 30x60 = 1 box
 Size: 33 x 63 x 14 cm
 Volume: 0,03 m³
 Weight: 1,4 kg.



FABRIC	CODE	RETAIL
HIGHLIGHT	C36 F-- ---	126 \$
GROUP 1	C36 F-- ---	142 \$
GROUP 2	C36 F-- ---	157 \$
GROUP 3	C36 F-- ---	205 \$
GROUP 4	C36 F-- ---	288 \$
COM fabric	C36 COM	126 \$

Fabric needed: 0,7 m (1 or 2 cushions)
 Leather needed: 0,7 x 0,7 m

SQUARE CUSHION

40 x 40 cm

Code: C40

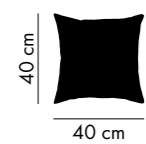

40x40 cm cushion weight: 0,85 Kg.

One 40x40 cushion is included with every Corner.

PACKING: 40 X 40 CUSHION

1 cushion 40x40 = 1 box
 Size: 40 x 40 x 14 cm
 Volume: 0,023 m³
 Weight: 1,2 kg.



FABRIC	CODE	RETAIL
HIGHLIGHT	C40 F-- ---	104 \$
GROUP 1	C40 F-- ---	117 \$
GROUP 2	C40 F-- ---	131 \$
GROUP 3	C40 F-- ---	175 \$
GROUP 4	C40 F-- ---	241 \$
COM fabric	C40 COM	104 \$

Fabric needed: 0,5 m
 Leather needed: dos piezas de 0,5 x 0,5 m

C O S T U R A



Gaudi FCG005

SATELLITE



S: FEF002, M: FEF015, L: FEF007, XL: FEF011.



Costura: FCG005. Satellite: FAM020



Two sets of monochrome panels combined

SATELLITE

FAST DELIVERY, SHIPS IN ONE WEEK AND AT A BETTER PRICE

4 PANELS IN THE SAME FABRIC



FAM060
HIGHLIGHT



CODE	RETAIL
SAT FAM060	1393 \$

4 PANELS - 4 MIXED FABRICS

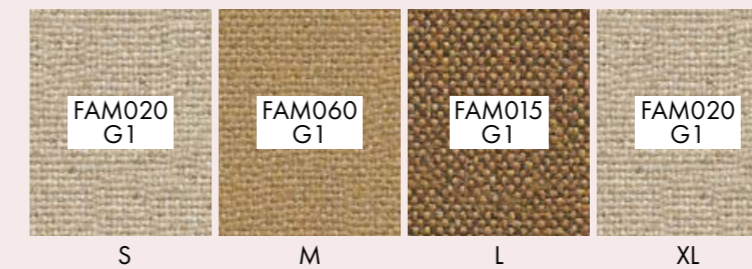

FAM020
G1

FAM060
G1

FAM015
G1

FAM020
G1



CODE	RETAIL
SAT MIX B	1393 \$

S

M

L

XL

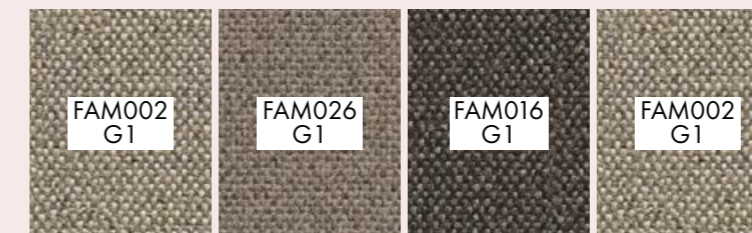

FAM002
G1

FAM026
G1

FAM016
G1

FAM002
G1



CODE	RETAIL
SAT MIX C	1393 \$

S

M

L

XL



FEF002
G2

FEF015
G2

FEF007
G2

FEF011
G2



CODE	RETAIL
SAT MIX D	1393 \$

S

M

L

XL

THESE SATELLITE PANELS ARE SHIPPED WITHIN 1 WEEK
THE REST ARE SHIPPED WITHIN 3 WEEKS

SATELLITE

ALL FABRICS ARE VALID

TECHNICAL TEXTILES CAMIRA. 100% Natural

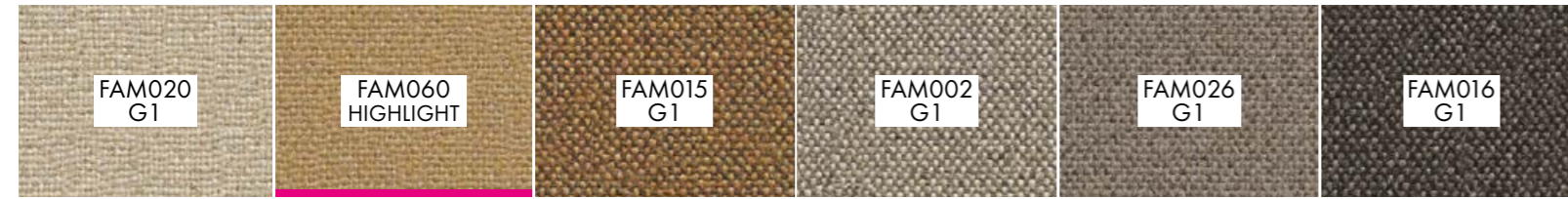

TECHNICAL TEXTILES KVADRAT. Classics

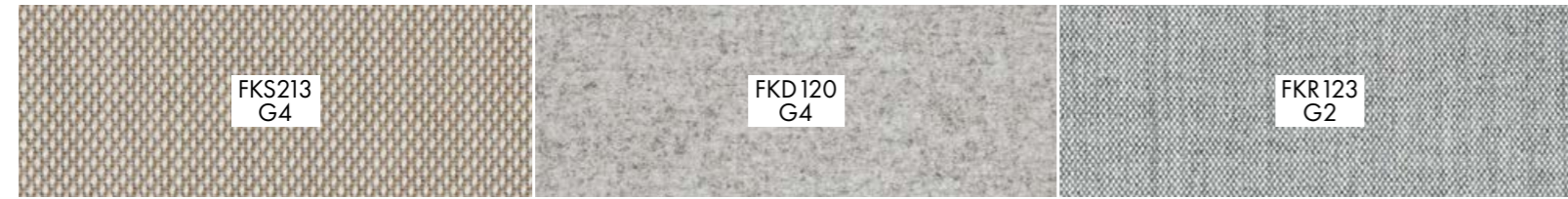

TECHNICAL TEXTILES VESCOM. Recycled



TECHNICAL TEXTILES VESCOM. Recycled



SOFT TOUCH TEXTILES - Light

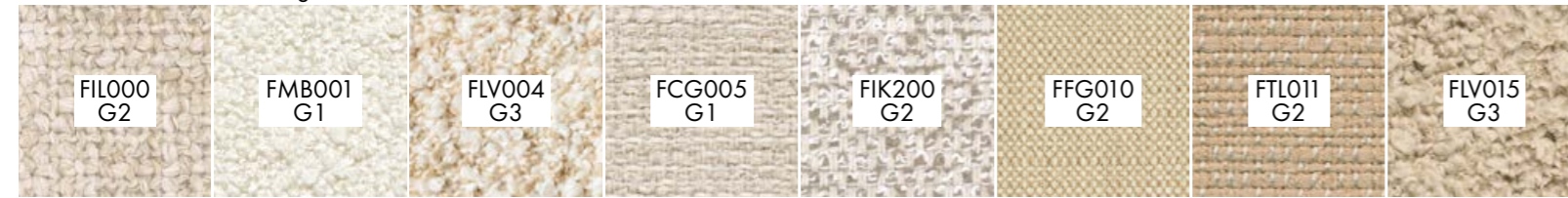

SOFT TOUCH TEXTILES - Warm

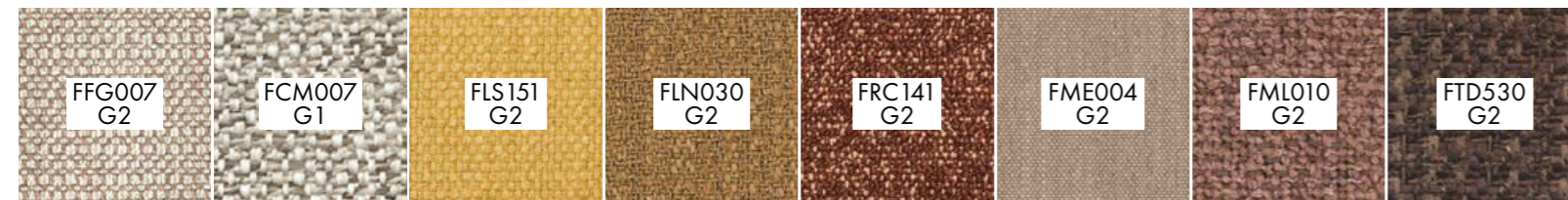

SOFT TOUCH TEXTILES - Cool

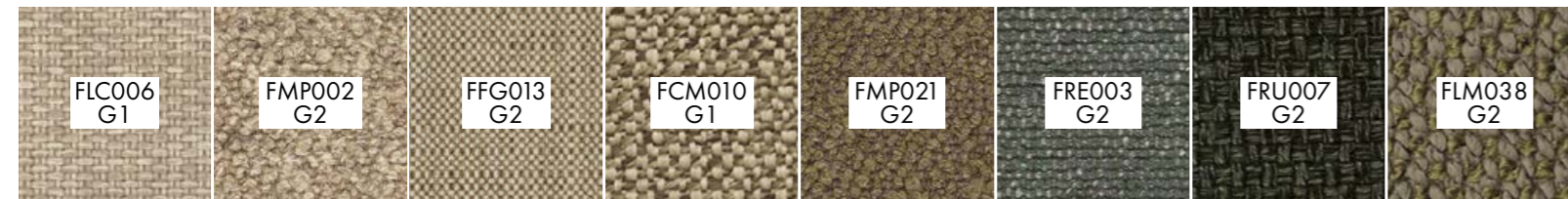

SOFT TOUCH TEXTILES - Grey



SATELLITE

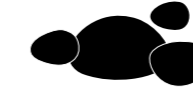

4 PANELS IN THE SAME FABRIC	CODE	RETAIL
SATELLITES FAST DELIVERY	SAT FAM060	1393 \$
FABRIC GROUP 1	SAT F-- ---	1436 \$
FABRIC GROUP 2	SAT F-- ---	1503 \$
FABRIC GROUP 3	SAT F-- ---	1548 \$
FABRIC GROUP 4	SAT F-- ---	1705 \$
COM FABRIC	SAT COM	1393 \$

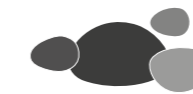

4 PANELS - MIXED FABRICS	CODE	RETAIL
MIX FAST DELIVERY	SAT MIX B, C, D	1393 \$
STUA FABRIC MIX	SAT MIX	1705 \$
STUA TECHNICAL FABRIC MIX IN OTHER COLOURS*	SAT MIX K	1705 \$
COM FABRIC	SAT COM	1393 \$

THE SATELLITE PANES HIGHLIGHTED IN PINK ARE SHIPPED WITHIN 1 WEEK
THE REST ARE SHIPPED WITHIN 3 WEEKS

*OTHER TECHNICAL FABRICS

The Satellite panels can be upholstered in other colours of our technical fabrics.
For each colour there is a extra cost. Concept without discount.

EXTRA COST	ADD
Add per fabric or colour	+122 \$

S A P P O R O



Ash doors with white stain on the other side



The perfect TV cabinet



Walnut doors with oak finish on the other side





The same doors, turned around

S A P P O R O



S A P P O R O

PAIR OF DOORS

REVERSIBLE WOOD	CODE	RETAIL
 <p>WALNUT OAK</p>	6006	211 \$
 <p>BLACK STAINED ASH WARM GREY STAINED ASH</p>	6002	211 \$
 <p>NATURAL ASH WHITE STAINED ASH</p>	6007	211 \$

Each code is for the pair of doors. The price includes both doors.

TEMPERED GLASS	CODE	RETAIL
 <p>TRANSPARENT</p>	6004	211 \$
 <p>FROSTED</p>	6000	211 \$

S A P P O R O

FAST DELIVERY, SHIPS IN ONE WEEK

UNITS		CODE	RETAIL
SAPPORO 1 UNIT RAL 9010		6104 W	1242 \$
SAPPORO 2 UNITS		6204 W	2009 \$
SAPPORO 3 UNITS		6304 W	2776 \$
SAPPORO 4 UNITS		6404 W	3542 \$
SAPPORO 5 UNITS		6504 W	4309 \$
SAPPORO 6 UNITS		6604 W	5076 \$

DOORS: Complete your furniture with the doors you want. Each unit comes with guides for the sliding doors.
CABLE MANAGEMENT: How many units do you want with cable management?

THE SAPPORO PANELS ARE SHIPPED WITHIN 1 WEEK

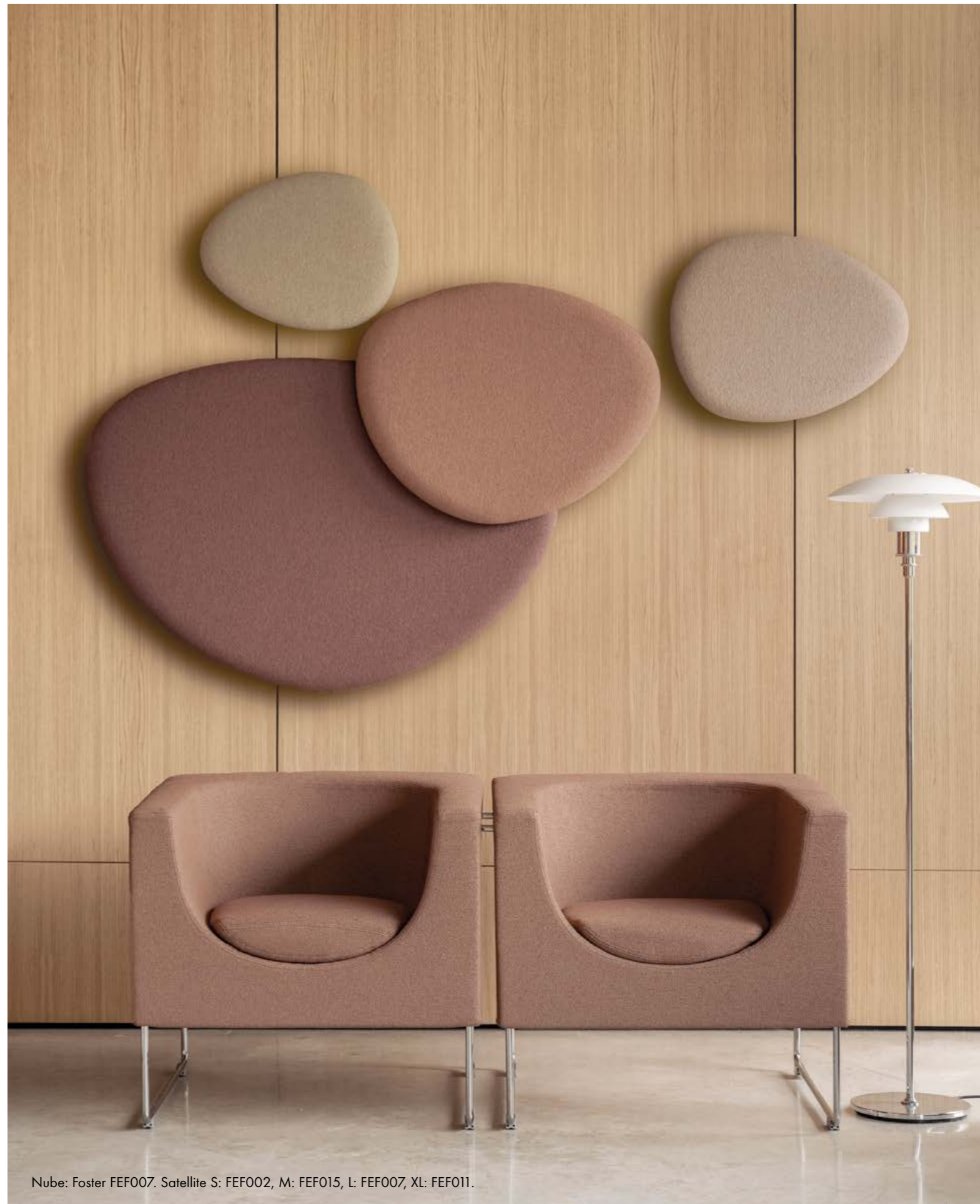

Nube: Foster FEFO07. Satellite S: FEFO02, M: FEFO15, L: FEFO07, XL: FEFO11.

STUA FABRIC COLLECTION

We want to inspire you, and for that we bring you fabrics made in some of the most unique mills in Europe. Mills that produce for Prada and Paul Smith. From them come exclusive fabrics manufactured only for STUA.

We offer four collections that we always keep in stock:

21 TECHNICAL FABRICS

We have added six 100% natural fabrics and twelve fabrics made from recycled plastic bottles, plus three Kvadrat classics.

Natural: 6 Main Line Flax fabrics by CAMIRA

Recycled: 12 fabrics by VESCOM

Classics: 3 fabrics by KVADRAT

32 SOFT-TOUCH FABRICS

These are soft-touch fabrics mainly produced in mills near Lake Como in Italy, or in Barcelona. Some are sophisticated and delicate, others are resistant for family life. See the table at the next page that shows the suitability of each fabric.

7 LEATHERS

Leather is a natural and surprisingly sustainable material, as it is a by-product of the food industry. At STUA we work with two of the best tanneries in Italy to offer two leather qualities:

Protected leather: 3 high-performance leathers coated with a thin varnish that makes them very resistant.

Natural leather: 4 leathers with lighter protection that age with a natural patina.

6 ARTIFICIAL LEATHER

Often called eco-leather or vegan leather, but in reality it is a plastic material made of polyurethane, available in 6 colours. An extremely resistant material with more than 500.000 Martindale.

UPHOLSTERY THAT COMPLY WITH UK CRIB 5

Fabrics: Camira Main Line Flax, Vescom Foster, Auckland, Norfolk

Artificial leather: Spradling Valencia, price G1

Leather: Extra from Antic Cuir, price G4

PRICES OF FABRICS

PRICE PER METRE OF FABRIC BY GROUP

GROUP 1	GROUP 2	GROUP 3	GROUP 4
88 \$/m	119 \$/m	160 \$/m	198 \$/m
GROUP 1	GROUP 2	GROUP 3	GROUP 4
BOUCLE	AGAMOTO	PADDINGTON	VELLUS
CICO	COSTA	SARAFINA	
GAUDI	DIAGO	UMBRA	
MOULIN	ELSA	KVADRAT	
CAMIRA	GUN	REMIX	
MAIN LINE	GENT	VESCOM	
FLAX		AUCKLAND	
VALENCIA	LEVANTE	VESCOM	
ARTIFICIAL	LIZZA	FOSTER	
LEATHER	LORETO	VESCOM	
	MAORI	NORFOLK	
	MEDITERRANEO		
	MORICONE		
	NAZZANO		

OTHER FABRICS FROM CAMIRA, VESCOM, KVADRAT OR SPRADLING OUTSIDE THE STUA COLLECTIONS

STUA offers a selection of fabrics from Vescom, Camira and Kvadrat. And now for the sanitary sector we offer the Valencia fabric from SPRADLING, from group 1, but always with the surcharge of ordering special material.

Please note: these fabrics are not part of our regular collection and therefore carry an extra cost of \$122 per fabric or colour.

Extra cost per fabric or colour: +122 \$ / fabric or colour

Concept without discount.

COM TEXTILES

STUA can manufacture upholstered products in COM fabric.

COM fabrics must be tested and approved by STUA.

Before placing a firm order, please send us a sample.

Upholstery in COM fabrics is not covered by STUA's guarantee.

Production times with COM fabrics: around 8 weeks.

TEXTILES: TECHNICAL INFORMATION

		WEIGHT gr./ml	FIRE RESISTANCE						HEALTHY MATERIAL					CLEANING		
			ABRASION Martindale	BS 5852 cigarette	BS 5852 match	Col. TB 117-2013	NFPA 260-2013	EN1021-Part 1:2006	ORKO-TEX	PFAS free	GREENGUARD	REACH compliance	RECYCLED		EASY CLEAN	WASHABLE
SOFT TOUCH	AGAMOTO VI 30% WO 16% LI 13% CO REC 12% PA 10% PES 9% SE 6% PC 4%	626	30.000	✓	✓				✓	✓	12%	✗	Ⓟ	✗	✗	G2
	BOUCLE 100% PES	956	100.000	✓	✓							30%	Ⓟ	✗	✗	G1
	CICO PP 100%	597	35.000	✓	✓			✓	✓	✓		40%	✗	✗	✗	G1
	COSTA PES 54% PCB 32% CO 9% WO 5%	1.000	40.000		✓								Ⓟ	✗	✗	G2
	DIAGO VI 55% CO 37% LI 8%	950	27.000	✓	✓				✓	✓			Ⓟ	✗	✗	G2
	ELSA LI 34% VI 31% WO 14% PES 11% CO 10%	1.090	25.000		✓								Ⓟ	✗	✗	G2
	GAUDI PP 60% PES 23% PES REC 13% CO REC 4%	680	46.000	✓	✓	✓	✓	✓	✓	✓	17%	✗	30%	Ⓟ	✗	G1
	GENT PAN 64% PES 17% VI 15% LI 4%	731	20.000	✓	✓	✓	✓	✓	✓	✓		✗	30%	Ⓟ	✗	G2
	GUN PP 88% PES 12%	648	30.000	✓	✓			✓	✓	✓			30%	✗	✗	G2
	LEVANTE PC 47% WO 19% PES 16% CO 15% PA 3%	900	30.000	✓	✓								Ⓟ	✗	✗	G2
	LIZZA VI 68% CO 29% LI 3%	1.000	25.000	✓	✓				✓				Ⓟ	✗	✗	G2
	LORETO VI 49% LI 22% PES 15% PA 8% CO REC 6%	1.180	100.000	✓	✓		✓	✓	✓	✓	6%		Ⓟ	✗	✗	G2
	MAORI PC 58% WO 20% PES 18% CO 4%	900	28.000	✓	✓								Ⓟ	✗	✗	G2
	MEDITERRANEO CO 39% VI 32% LI 16% PES 13%	700	40.000	✓	✓							NEUTRAL SOAP	Ⓟ	✗	✗	G2
	MORICONE PP 100%	995	80.000		✓			✓	✓	✓			40%	✗	✗	G2
	MOULIN PP 80% PES REC 14% CO REC 3% OF REC 3%	770	80.000	✓	✓	✓	✓	✓	✓	✓	20%	✗	30%	✗	✗	G1
	NAZZANO CO REC 35% VI 32% PES 18% LI 15%	940	25.000					✓	✓	✓	35%		Ⓟ	✗	✗	G2
	PADDINGTON PC 28% CO 27% VI 21% WO 14% PES 7% PA 3%	1.130	30.000	✓	✓								Ⓟ	✗	✗	G2
	SARAFINA VI 34% CO 31% LI 15% PC 13% PES 7%	940	30.000	✓	✓				✓		31%		Ⓟ	✗	✗	G2
	UMBRA VI 51% LI 25% CO 18% PES 6%	1.120	25.000		✓								Ⓟ	✗	✗	G2
VELLUS PC 35% WV 30% PES 22% CO 13%	1.000	80.000	✓	✓	✓			✓	✓			Ⓟ	✗	✗	G3	
TECHNICAL	CAMIRA MAIN LINE FLAX WV 75% LI 25%	612	50.000	✓	✓	✓	✓	✓	✓	✓		✗	Ⓟ	✗	G1	
	KVADRAT REMIX WO 90% PES 10%	420	100.000	✓	✓	✓	✓	✓	✓			✗	Ⓟ	✗	G2	
	KVADRAT STEELCUT TRIO WO 90% PES 10%	770	100.000	✓	✓	✓	✓	✓	✓			✗	Ⓟ	✗	G4	
	KVADRAT DIVINA MELANGE WO 100%	840	45.000	✓	✓	✓	✓	✓	✓			✗	Ⓟ	✗	G4	
	VESCOM FOSTER PES REC 97% PES 3%	749	100.000	✓	✓	✓	✓	✓	✓	97%		✗	Ⓟ	✗	G2	
	VESCOM AUCKLAND PES REC 76% PES 24%	704	80.000	✓	✓	✓	✓	✓	✓	76%		✗	Ⓟ	✗	G2	
	VESCOM NORFOLK PES REC 100%	624	70.000	✓	✓	✓	✓	✓	✓	100%		✗	Ⓟ	✗	G2	
	ARTIFICIAL LEATHER EXTERIOR: PU 100% INTERIOR: PES 100%	868	500.000	✓	✓	✓	✓	✓	✓	✓			✗	✗	✗	G1

CO Cotton PA Polyamide PCB Polycarbonate PU Polyurethane VI Viscose
 LI Linen PAN Polyacrylonitrile PES Polyester REC Recycled WO Wool
 OF Yarn from waste PC Polyacrylic PP Polypropylene SE Silk WV Virgin wool

SUITABILITY OF EACH FABRIC

	LIBERA	COSTURA	MALENA	NUBE	CALMA	SATELLITE	GAS	EGOA	LACLASICA	GLOBUS	VALID FOR OUTDOOR
AGAMOTO FLA003	✓	✓	✓	✓	✓	✓	✓	✓	✓	✓	
BOUCLE FMB001	✓	✓	✓	✓	✓	✓	✗	✓	✓	✓	
CICO FLC002 FLC006 FLC256 FLC259	✓	✓	✓	✗	✓	✓	✓	✓	✓	✓	☀️
COSTA FRC141	✓	✓	✓	✓	✓	✓	✗	✓	✓	✓	
DIAGO FTD520 FTD530	✓	✓	✓	✓	✓	✓	✗	✓	✓	✓	
ELSA FRE003	✓	✓	✓	✓	✓	✓	✗	✓	✓	✓	
GAUDI FCG005	✓	✓	✓	✓	✓	✓	✓	✓	✓	✓	
GENT FFG007 FFG010 FFG013	✓	✓	✓	✗	✓	✓	✗	✓	✓	✓	
GUN FK200	✓	✓	✓	✓	✓	✓	✓	✓	✓	✓	☀️
LEVANTE FML010 FML011	✓	✓	✓	✓	✓	✓	✗	✓	✓	✓	
LIZZA FTL011	✓	✓	✓	✓	✓	✓	✗	✓	✓	✓	
LORETO FIL000	✓	✓	✓	✓	✓	✓	✗	✓	✓	✓	
MAORI FMM012 FMM016	✓	✓	✓	✓	✓	✓	✗	✓	✓	✓	
MEDITERRANEO FME004	✓	✓	✓	✗	✓	✓	✓	✓	✓	✓	
MORICONE FLM038	✓	✓	✓	✓	✓	✓	✗	✓	✓	✓	☀️
MOULIN FCM007 FCM010	✓	✓	✓	✓	✓	✓	✓	✓	✓	✓	
NAZZANO FLN030	✓	✓	✓	✓	✓	✓	✗	✓	✓	✓	
PADDINGTON FMP002 FMP021	✓	✓	✓	✓	✓	✓	✗	✓	✓	✓	
SARAFINA FLS151	✓	✓	✓	✓	✓	✓	✓	✓	✓	✓	
UMBRA FRU007	✓	✓	✓	✓	✓	✓	✗	✓	✓	✓	
VELLUS FLV004 FLV015	✓	✓	✓	✓	✓	✓	✗	✓	✓	✓	
CAMIRA MAIN LINE FLAX FLA002 015 016 020 026 060	✓	✓	✓	✓	✓	✓	✓	✓	✓	✓	
KVADRAT REMIX FKR123	✓	✓	✓	✗	✓	✓	✗	✗	✗	✗	
KVADRAT STEELCUT TRIO FKS213	✓	✓	✓	✓	✓	✓	✓	✓	✓	✓	
KVADRAT DIVINA MELANGE FKD120	✓	✓	✓	✓	✓	✓	✓	✓	✓	✓	
VESCOM FOSTER FEF001 002 003 007 011 015 021	✓	✓	✓	✓	✓	✓	✓	✓	✓	✓	
VESCOM AUCKLAND FEA004 FEA019 FEA033	✓	✓	✓	✓	✓	✓	✓	✓	✓	✓	
VESCOM NORFOLK FEN005 FEN009	✓	✓	✓	✓	✓	✓	✓	✓	✓	✓	
ARTIFICIAL LEATHER FET002 004 005 006 007 009	✓	✓	✓	✓	✓	✗	✓	✓	✓	✓	

✓ Recommended
 ✗ Not recommended

TECHNICAL TEXTILES

CAMIRA. 100% NATURAL



G1
CAMIRA MAIN LINE FLAX 20
FAM020



G1
CAMIRA MAIN LINE FLAX 60
FAM060



G1
CAMIRA MAIN LINE FLAX 15
FAM015



G1
CAMIRA MAIN LINE FLAX 02
FAM002



G1
CAMIRA MAIN LINE FLAX 26
FAM026



G1
CAMIRA MAIN LINE FLAX 16
FAM016

KVADRAT. CLASSICS



G4
KVADRAT STEELCUT TRIO 213
FKS213

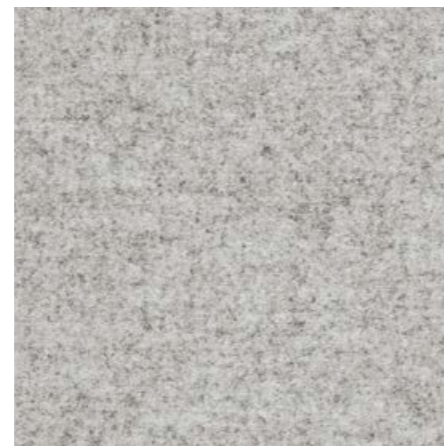

G4
KVADRAT DIVINA MELANGE 120
FKD120

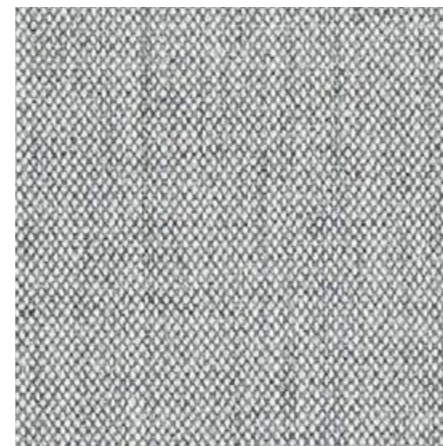

G2
KVADRAT REMIX 123
FKR123
Remix is
not valid
for chairs

TECHNICAL TEXTILES

VESCOM. RECYCLED

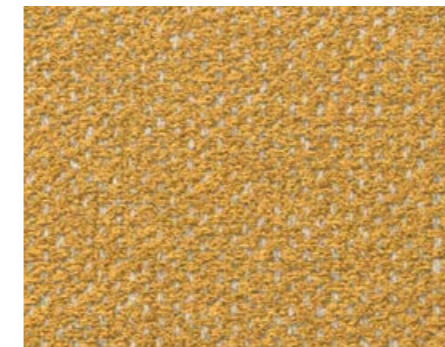

G2
VESCOM FOSTER 1
FEF001



G2
VESCOM AUCKLAND 19
FEA019



G2
VESCOM FOSTER 2
FEF002

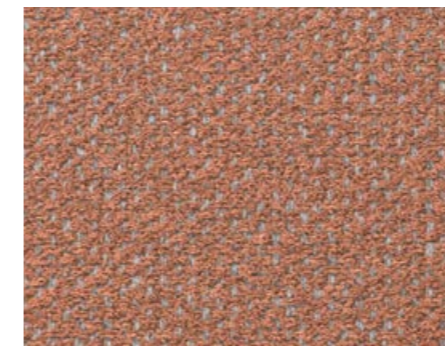

G2
VESCOM FOSTER 7
FEF007

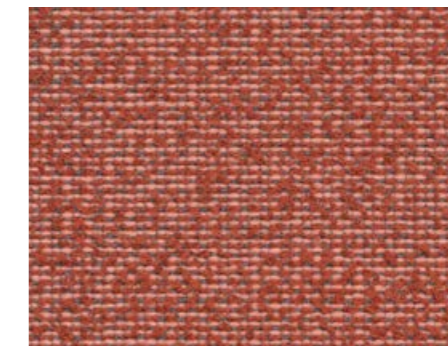

G2
VESCOM AUCKLAND 33
FEA033



G2
VESCOM FOSTER 11
FEF011



G2
VESCOM FOSTER 15
FEF015



G2
VESCOM NORFOLK 5
FEN005



G2
VESCOM FOSTER 3
FEF003

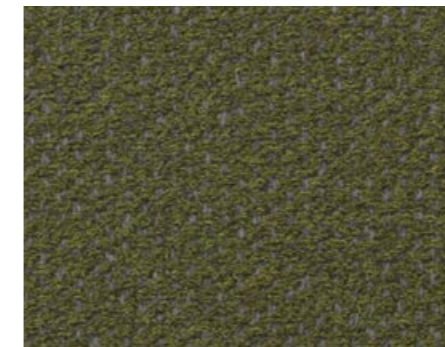

G2
VESCOM FOSTER 21
FEF021



G2
VESCOM AUCKLAND 4
FEA004



G2
VESCOM NORFOLK 9
FEN009

SOFT TOUCH TEXTILES

LIGHT



G2
LORETO 0
FILO00



G1
BOUCLE 1
FMB001

HIGHLIGHT
LIBERA
MALENA
NUBE
CALMA



G3
VELLUS 4
FLV004



G1
GAUDI 5
FCG005

HIGHLIGHT
COSTURA

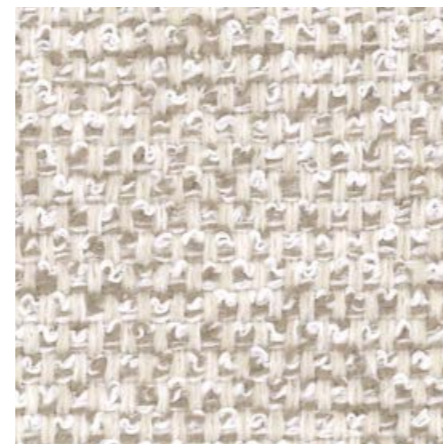

G2
GUN 6
FIK200



G2
GENT 10
FVG010



G2
LIZZA 011
FTL011



G3
VELLUS 15
FLV015

SOFT TOUCH TEXTILES

WARM



G2
GENT 7
FFG007

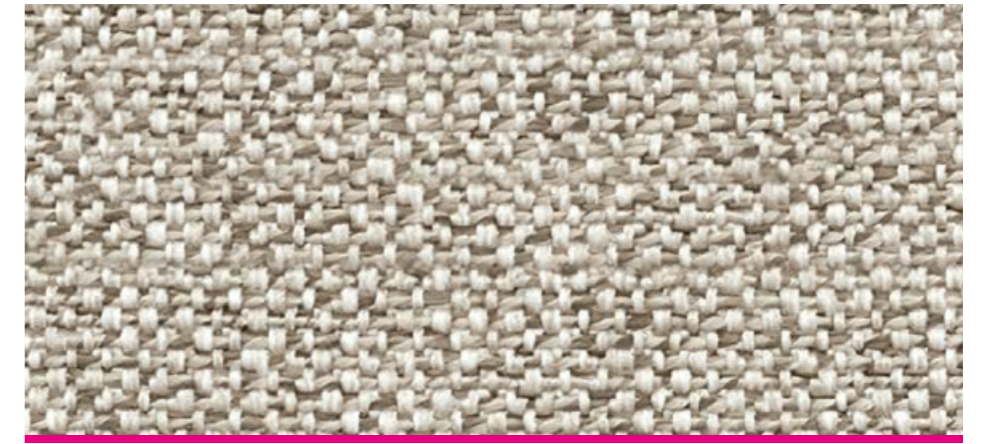

G1
MOULIN 7
FCM007

HIGHLIGHT
COSTURA
LIBERA
MALENA
NUBE
CALMA



G2
SARAFINA 151
FLS151



G2
NAZZANO 30
FLN030

HIGHLIGHT
LIBERA
MALENA
NUBE
CALMA



G2
COSTA 141
FRC141



G2
MEDITERRANEO 4
FME004



G2
LEVANTE 10
FML010

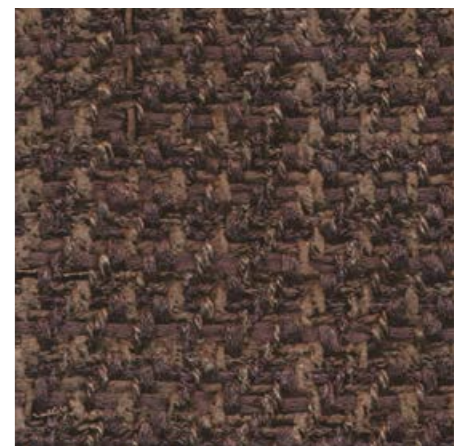

G2
DIAGO 530
FTD530

SOFT TOUCH TEXTILES

COOL



G1
CICO 6
FLC006

HIGHLIGHT
CALMA OUTDOOR



G2
PADDINGTON 2
FMP002

HIGHLIGHT
LIBERA
MALENA
NUBE
CALMA



G2
GENT 13
FFG013

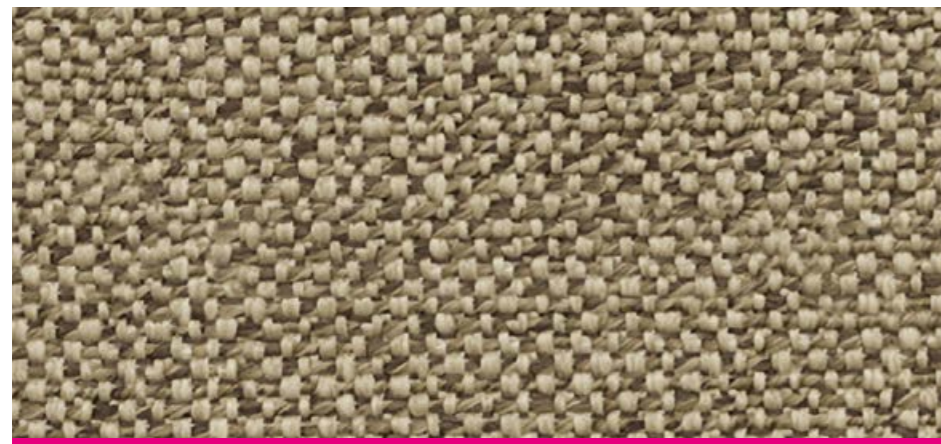

G1
MOULIN 10
FCM010

HIGHLIGHT
COSTURA



G2
PADDINGTON 21
FMP021



G2
ELSA 3
FRE003



G2
UMBRA 7
FRU007



G2
MORICONE 38
FLM038

SOFT TOUCH TEXTILES

GREY



G1
CICO 256
FLC256



G2
MAORI 16
FMM016



G2
DIAGO 520
FTD520



G2
AGAMOTO 3
FLA003



G2
LEVANTE 11
FML011



G1
CICO 2
FLC002

HIGHLIGHT
CALMA OUTDOOR



G2
MAORI 12
FMM012

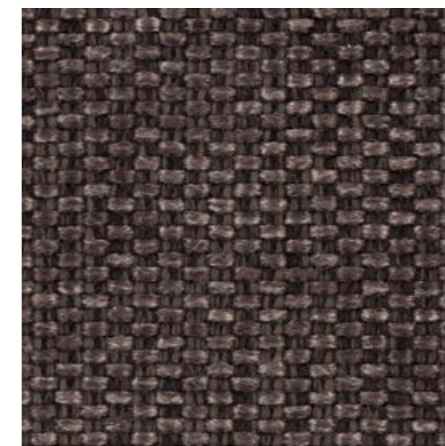

G1
CICO 259
FLC259

Six Indoor and outdoor fabric

Easy clean

Machine washable

Recycled raw materials
Our three featured fabrics include recycled materials

ARTIFICIAL LEATHER

POLYURETHANE



G1
FET004
WHITE



G1
FET005
DOVE



G1
FET009
ELEPHANT



G1
FET006
TERRA



G1
FET007
COGNAC



G1
FET002
BLACK

ARTIFICIAL POLYURETHANE LEATHER

High performance, artificial leather alike made of robust polyurethane. It's not leather, it's imitation leather.

Stain protection.

High Scratch Resistance.

Resistant to urine and hospital-grade cleaners.

Resistance to Hydrolysis: 8 Years.

Suitable for home and contract use.

PROTECTED LEATHER

Smooth natural grain leather slightly corrected.

Lightly pigmented, it is a covered leather. It can show the animal's own wrinkles.

A comfortable leather with a natural feel and at the same time offering great durability that can withstand the stress and wear and tear of public places.

Produced in Italy from European cattle.

Meet the REACH regulation.

Recommended at home and for contract use.

NATURAL LEATHER

Full grain semi-aniline bovine leather.

Chrome tanning, passing dyeing, refinement made with resins and natural pigments.

High quality leather characterised by its naturalness and versatility, ductile touch and semi-opaque aspect.

Its special drying, 'sotto vuoto', facilitates the recovery and spring of the leather in the sitting.

Produced in Italy from European cattle.

Recommended mainly at home.

LEATHER

PROTECTED FOR HARD USE

This leather has a protective coating for contract projects.



G4
FCG000
SAND



G4
FCG003
COGNAC



G4
FCG002
BLACK

NATURAL SOFT TOUCH

Leather with lighter, more natural protection.



G4
FFB004
SABBIA



G4
FFB005
WOOD



G4
FFB006
FANGO



G4
FFB007
VERDONE

WOOD

NATURAL WOOD



OAK

LAMINATE



BLACK LAMINATE

HPL



BLACK HPL

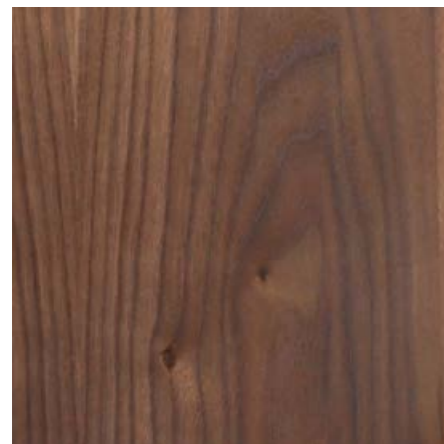

WALNUT

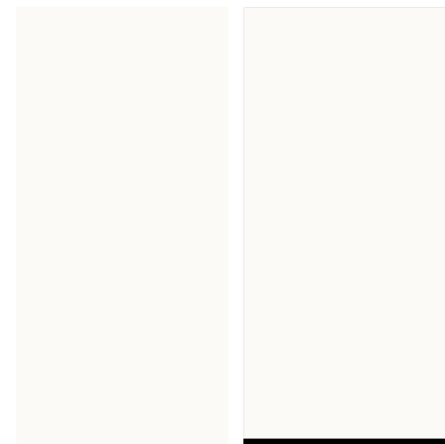

WHITE HPL
White core

WHITE HPL
Black core

NATURAL OR STAINED WOOD

STUA works with natural wood, both veneer and solid wood, depending on the product. We use oak, walnut or ash.

Natural wood comes in three finishes:

- natural acrylic varnish
- stained
- lacquered

Wood is a living material. Variations in the grain pattern and background colour are completely normal. Slight tone differences between products are always possible, even when the same stain is used.

BLACK LAMINATE

Super-resistant material with a natural feel and easy maintenance. With antiviral and antibacterial properties. Perfect for table tops subject to heavy use.

Interior: Black MDF. Made from wood fibres pressed with synthetic resins.

Thickness: 20 mm.

HPL - HIGH PRESSURE LAMINATE

Also known as Compact, this is a very hard material created from wood pulp and phenolic resins subjected to high pressure.

Hygienic and easy to clean.

Suitable for indoor and outdoor use.

Thicknesses: 10 and 12 mm.

WOOD

ASH - NATURAL & STAINED



NATURAL ASH



WHITE STAINED



WHITE LACQUERED

Chairs in ash open pore.
Tabletops are flat.



STAINED IN OAK TONE



STAINED IN WALNUT TONE

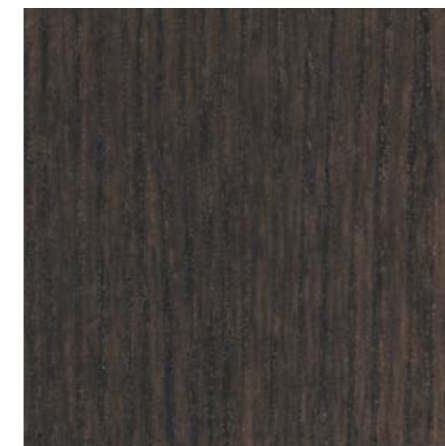

WARM GREY STAINED



BLACK STAINED/LACQUERED

PLASTIC

POLYPROPYLENE - 100% RECYCLED



BLACK



GREEN



TAUPE



STONE

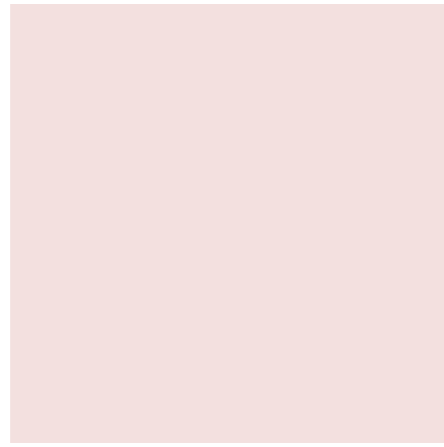

PINK

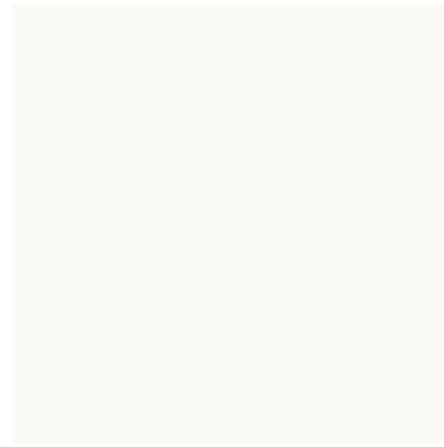

WHITE



STUA

P R I C E B O O K 2 0 2 6

R E T A I L P R I C E S I N \$ F O R T H E U S A

STUA
Donostia Ibilbidea 30
E20115 Astigarraga
Guipúzcoa
Spain

CONTACT
T: + 34 943 330 188
Commercial enquiries: stua@stua.com
Orders: export@stua.com
www.stua.com